

Radial - Wellendichtringe / Oil - Seals

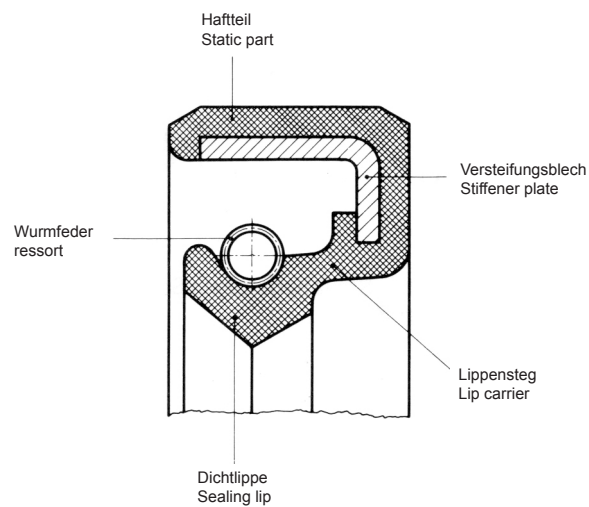

Beschreibung

Der Radialdichtring ist das meist verwendete Dichtelement zur Abdichtung rotierender Maschinenteile. Er besteht aus einem mit Blech verstärktem stabilen Körper, einer elastischen Dichtlippe und einer in die Federrille eingelegten Wurmfeder.

Description

Radial seals are the means most commonly used to seal the rotating parts of machines. They consist of a solid moulding reinforced with metal, an elastic sealing lip and a garter spring inserted in the spring groove.

Ausführungsformen / embodiments

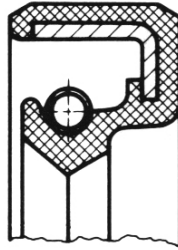

Bauform A

Standardausführung

Durch den gummielastischen Außenmantel können Wärmedehnung und eine größere Rauheit der Gehäusebohrung überbrückt werden. Keine Beschädigung der Gehäusebohrung bei öfterem Wechsel der Dichtung. Besonders geeignet zur Abdichtung gasförmiger oder dünnflüssiger Medien.

Type A

Standard type

Thermal expansion and considerable superficial roughness in the housing bore can be absorbed by the elastic outer casing. Frequent seal changes do not result in damage to the housing bore. Particularly suitable as a seal against gaseous or low-viscosity media.

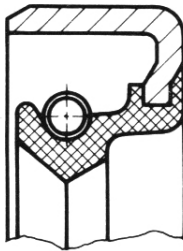

Bauform B

Metallisches Gehäuse, leichtes Einpressen erfordert engere Toleranzen der Gehäusebohrung, besonders bei kleiner Differenz zwischen Außen- und Innendurchmesser verwendet.

Type B

Metal casing, for ease of insertion the housing bore must be made to close tolerances, used particularly when the difference between external and internal diameters is small.

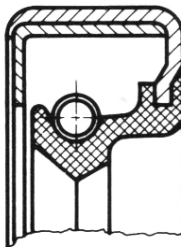

Bauform C

Metallisches Gehäuse mit Versteifungsring. Für rauen Betrieb und größere Abmessungen.

Type C

Metal casing with stiffening ring. For heavy-duty applications where dimensions are rather large.

Ausführungsformen / embodiments

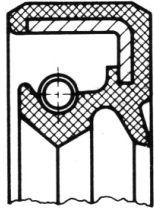

ASL

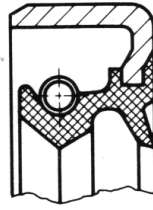

BSL

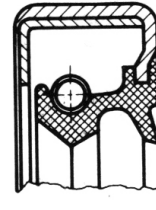

CSL

Bauform SL

Mit zusätzlicher Staublippe gegen Schmutz- und Rostgefahr.

Type SL

With additional dust lip to protect against dirt and corrosion.

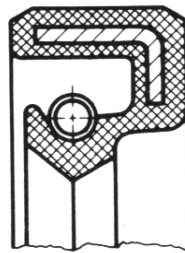

Bauform DAG

Blech vollkommen in Gummi eingebettet; dadurch besonders korrosionsgeschützt.

Type DAG

Metal stiffener totally encased in rubber and thus particularly protected against corrosion.

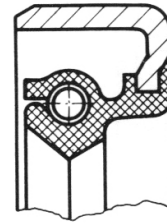
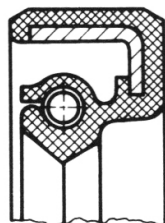

Bauform DAX, DBX

Ringe mit eingebetteter Wurmfeder. Schutz gegen Verschmutzung. Auslaufende Baureihe, wird ersetzt durch schlauchgeschützte Feder.

Type DAX, DBX

Seals with embedded garter spring. Protection against dirt. This type is being phased out to be replaced by a version in which the spring is protected in a tube.

Ausführungsformen / embodiments

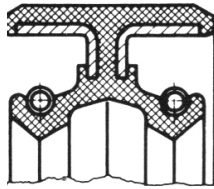

ADUO

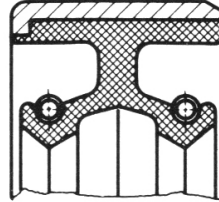

BDUO

Bauform ADUO, BDUO

Zwei gegeneinander stehende Dichtlippen, zur Trennung zweier Medien.

Type ADUO, BDUO

Two opposing sealing lips, to separate two media

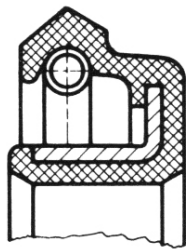

DAI

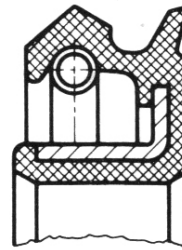

DAISL

Bauform DAI, DAISL

Zur Abdichtung umlaufender Gehäuse. Nur bei nicht allzu hohen Ansprüchen auf Dichtheit und geringen Drehzahlen verwendbar.

Type DAI, DAISL

To seal rotating housings. Can only be used where sealing requirements are not especially stringent and speeds are low.

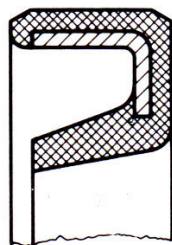

AoF/DINA

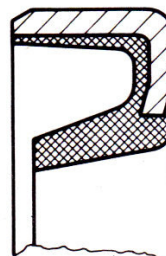

BoF

Bauform AoF/DINA, BoF

Radialdichtringe ohne Wurmfeder. Nur für untergeordnete Abdichtfälle verwenden.

Type AoF, BoF

Radial seals with no garter spring. Only use for secondary sealing applications.

Ausführungsformen / embodiments

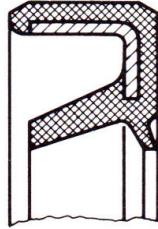

AoFSL

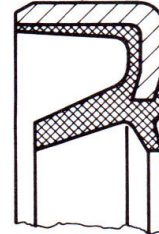

BoFSL

Bauform AoFSL, BoFSL

Wie Bauform AoF, BoF zu verwenden, jedoch mit zusätzlicher Staublippe.

Type AoFSL, BoFSL

To be used like type AoFSL, BoFSL, but has no dust-lip in addition.

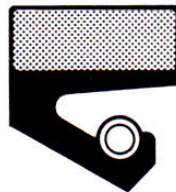

DBM

Bauform DBM

Ohne Versteifungsring.
Wird dort nur verwendet, wo aus einbautechnischen Gründen ein Einpressen in die Aufnahmebohrung nicht möglich ist.

Type DBM

No stiffening ring.
Only used where assembly requirements make it impossible to press the seal into its housing bore.

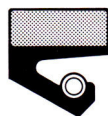

DBM50

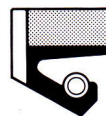

DBM60

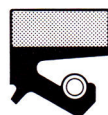

DBM50

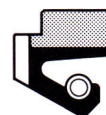

DBM70

DBM50: standard profile

DBM50: with additional dust lip

DBM60: with ports in the base usually twin fitted back to back, with anular groove in the housing allowing lubricant to pass around to the sealing lips

DBM70: with anular groove in addition to ports, allowing lubricant to pass around to the sealing lips. Usually twin fitted back to back

Ausführungsformen / embodiments

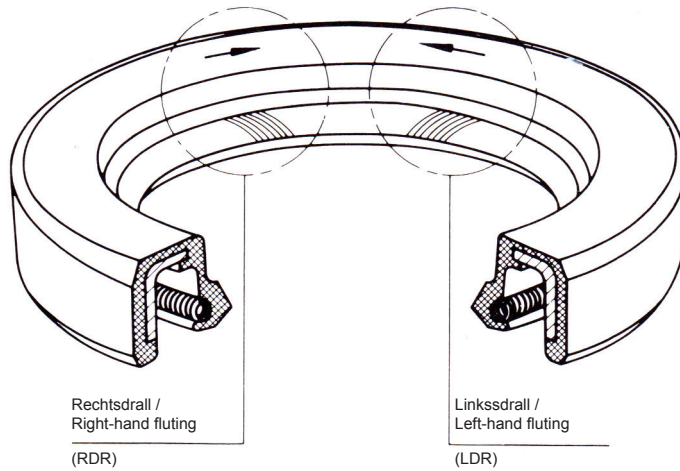

Radialdichtringe mit Rückförderfall

Sonderausführungen haben sich besonders bei Maschinen mit starken Schwingungen bewährt (Kurbelwellenabdichtung). Die Wirkungsweise ist mit der eines Rückfördergewindes vergleichbar.

Radial seals with back-feed fluting

Special types have proved to be particularly effective in machines where vibration levels are high (crankshaft seals). They work in much the same way as a back-feed thread.

Pfeilrichtung = Wellendrehrichtung

Arrows indicate direction of rotation of shaft

Der Rückförderdrall wird je nach Bestellmenge angeschliffen oder angepresst.

The back-feed fluting is ground or stamped depending on the quantity ordered.

Weiters haben wir noch eine Reihe anderer Sonderausführungen z.B. mit verlängerter, verstärkter Dichtlippe, Ringe mit Einspannflansch usw., in unserem Programm.

We also have a further selection of other special types in our range, e.g. with elongated reinforced sealing lips, seals with mounting flanges, etc.

Bezüglich der Form ist in unserem Werk rückzufragen.

Enquiries regarding forms should be addressed to our works.

Vorteile

1. Einsatz in druckbeaufschlagten Aggregaten
2. Sichere Abdichtung zur Gehäusebohrung, auch bei erhöhter Rauheit der Bohrung, Wärmedehnung und geteilten Gehäusen
3. Vorteile zur Abdichtung von dünnflüssigen und gasförmigen Wellen
4. Erhöhte thermische Stabilität und chemische Beständigkeit bei Verwendung von FKM

Advantages

1. Operates within pressurised units
2. Secure sealing to the housing bore, even with increased roughness of the bore, thermal expansion and split housings
3. Suitable for sealing of low viscosity and gaseous media
4. Increased thermal stability and chemical resistance with use of FKM

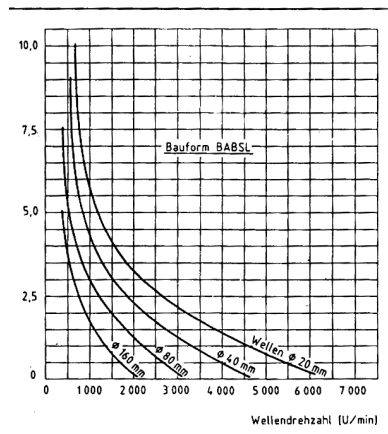

Werkstoffübersicht für Radial - Wellendichtringe

Werkstoffbezeichnung	Basis	Härte (Shore A)	Farbe	Temperaturbereich °C allgemein	zulässige Dauertemperatur der abzudichtenden Medien °C									
					Motorenöle	Getriebeöle	Hypoidgetriebe	ATF - Öle	Druckflüssigkeiten DIN 51 524	Fette	Hezöle EL + L	Wasser		Waschlaugen
NBR	Acrylnitril / Butadien K.	75	schwarz	-25 / +100	100	80	80	100	90	90	90	90	90	Standard-qualität
ACM	Acrylnitril / Butadien K.	76	schwarz	-25 / +110	110	80	80	100	90	90	90	-	-	weicher, höhere Temp.
FKM	Fluor - K.	75	braun	-20 / +200	170	150	150	170	150	+	150	-	-	besonders chem. beständig
VMQ	Silikon - K.	75	rot	-50 / +200	150	130	-	+	+	+	-	-	-	größter Temperaturbereich

Einsatzgebiet

Radialdichtringe sind bis zu einem Druck von ungefähr 0,5 bar einsetzbar. Bei höherem Druck besteht die Gefahr einer Deformation der Dichtlippe, daher ist diese mit einem Stützring abzustützen.

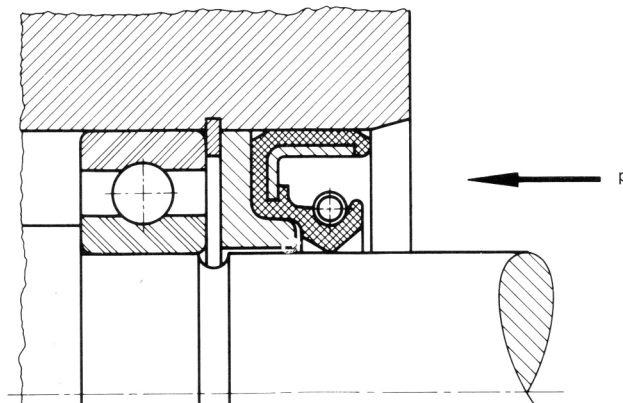

Die Höhe der maximalen Druckbelastigkeit ist abhängig von der Umfangsgeschwindigkeit sowie dem Durchmesser und liegt bei ungefähr 5 bar. Ausreichende Schmierung vorausgesetzt.

Werkstoffübersicht / Vakuum

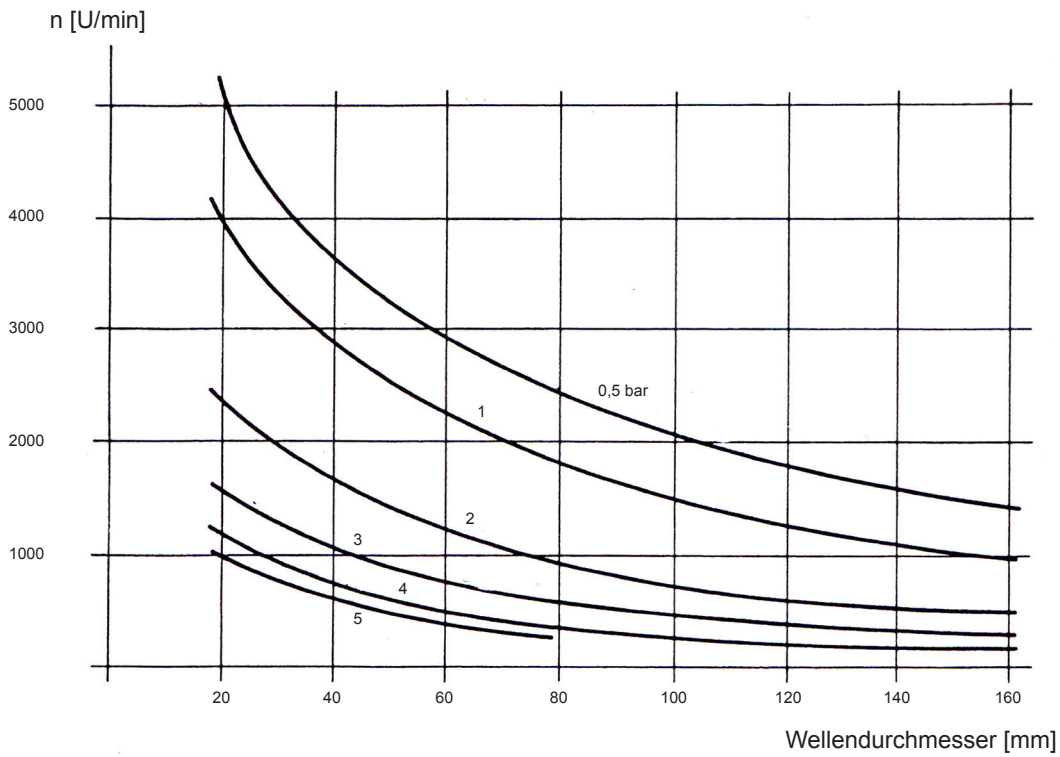

Vakuum

Vakuum ist wesentlich schwerer abzudichten, da schon kleinste Leckagen die Einhaltung eines geforderten Vakuums unmöglich machen.

Es empfiehlt sich 2 Radialdichtringe hintereinander zu schalten und den Zwischenraum mit Hochvakuumfett auszufüllen.

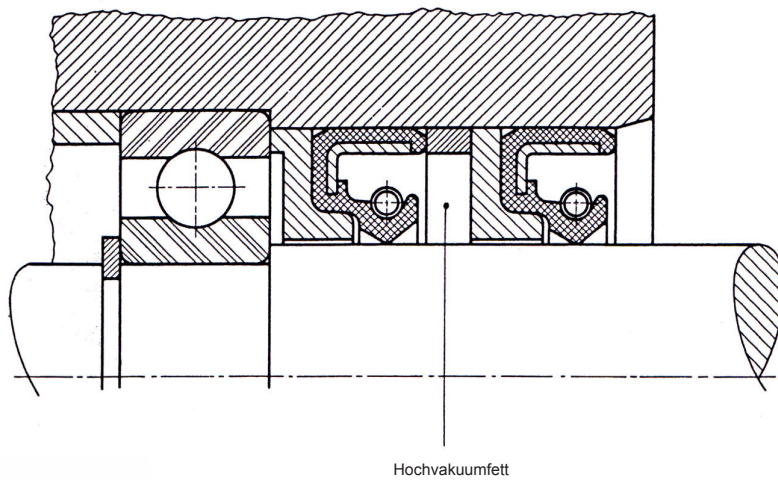

Werkstoffübersicht für Radial - Wellendichtringe

Schmierung

Für die richtige Schmierung sind folgende Punkte zu beachten:

Die Dichtlippe darf unter keinen Umständen trockenlaufen. Deshalb ist bereits bei der Montage durch Einfetten und Einölen der Welle und Dichtlippe für Schmierung bei den ersten Umdrehungen zu sorgen.

Ist das abzudichtende Betriebsmittel schmierfähig, so muß es ungehinderten Zutritt zum Dichtring haben.

Bei Abdichtung von Medien mit schlechten Schmiereigenschaften sollte die Dichtlippe extra geschmiert werden. Dies geschieht bei den Radialdichtringen mit Staublippe durch Ausfüllen des Raumes zwischen Dicht- und Staublippe mit Fett.

Günstiger ist die Anordnung von zwei hintereinanderliegenden Radialdichtringen. Der Raum zwischen den beiden ist mit Öl oder Fett auszufüllen, wobei eine Nachschmiermöglichkeit mittels Schmiernippel oder Öl vorzusehen ist.

Das Schmiermittel hat zugleich auch die Aufgabe, die durch Reibung entstehende Wärme abzuführen. Es muß sich daher ungehindert ausbreiten können.

Besondere Beachtung ist der unter Umständen beträchtlichen Pumpwirkung mancher Wälzlager (bes. Kegelrollenlager) zu schenken. Dadurch können unterschiedliche Ölstände eintreten, die mangelhafte Schmierung oder gar Trockenlauf verursachen können.

Entsprechende Bohrungen in den Gehäusen für den Druckausgleich sind schon bei der Konstruktion festzulegen.

Allgemein ist zu bemerken, daß ein geringfügiger Ölverlust besser ist als ein Trockenlauf der Dichtlippe. Trockenlauf verursacht eine Verhärtung der Dichtlippe und damit ein Versagen der Dichtung.

Reibung

Die Reibung steht in engem Zusammenhang mit der Schmierung.

Das durch Kapillarwirkung in den Dichtspalt gelangende Schmiermedium bildet einen tragfähigen Schmierfilm für die Dichtlippe, welcher unter kleinstmöglichen Reibungskräften gleitet.

Die Reibung ist abhängig von:

der Drehzahl,
dem Durchmesser der Welle,
der Oberflächenbeschaffenheit der Welle,
der Benetzbarkeit des Wellenwerkstoffes,
Art und Viskosität des Schmiermittels,
der Lippenvorspannung,
der Art und Härte des Manschettenwerkstoffes, usw.

Haben Sie Dichtungsprobleme, so fragen Sie bitte vor der Fertigstellung Ihrer Konstruktion bei uns an. Wir stehen mit der Ausarbeitung von Vorschlägen gerne zur Verfügung und behandeln Ihre Unterlagen selbstverständlich streng vertraulich. Die am Schluss dieses Kataloges eingelebten Fragebogen bitten wir ausgefüllt und mit Zeichnungen versehen an uns einzusenden.

Werkstoffübersicht / Montagehinweise

Montagehinweise

1. Vor der Montage ist der Radialdichtring zu prüfen, ob er keine Beschädigungen aufweist und ob die Wurmfeder richtig sitzt.
2. Der Radialdichtring ist an der Oichtlippe und am Außenumfang einzufetten.
(Verhindert Trockenlauf im Einlaufstudium)
3. Der Ring ist mit der Lippenseite gegen das abzudichtende Medium (innere Druckseite) einzubauen.
4. Für eine sichere Montage sind die in DIN 3760 Tabelle 5 angegebenen Werte einzuhalten.
5. Zur Überwindung unvermeidlicher Absätze müssen Montagehilfswerkzeuge verwendet werden.

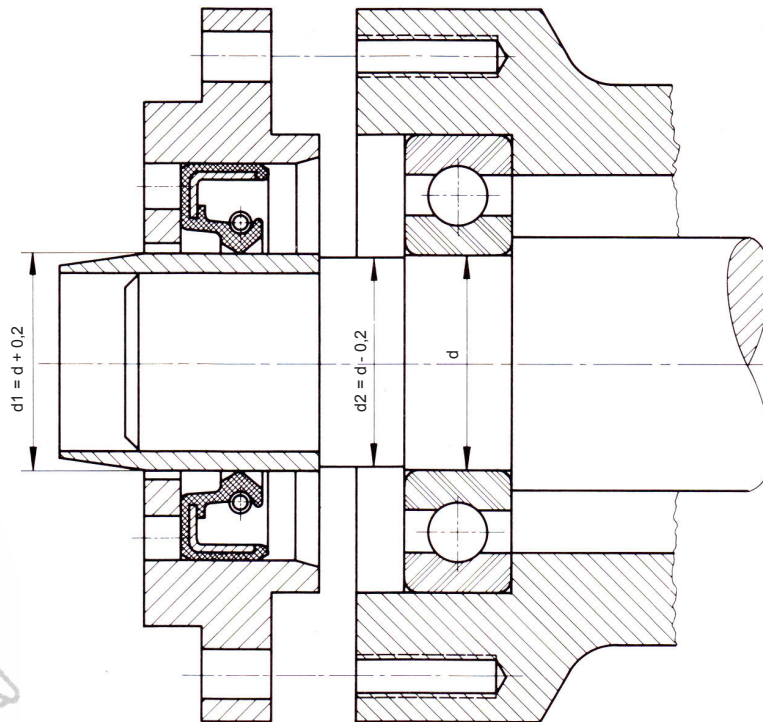

6. Über die Laufstelle auf der Welle darf kein Teil mit Preßpassung geschoben werden. In solchen Fällen ist die Welle »0,2 mm abzusetzen.
7. Die Radialdichtringe haben am Außendurchmesser eine Preßsitzzugabe, welche einen festen und sicheren Sitz gewährleistet.

Um den Einbau zu erleichtern und Beschädigungen zu verhindern, ist der Eingang der Bohrung anzuschrägen und zu entgraten.
8. Richtwerte für die Ausführung der Gehäusebohrung sind der DIN 3760, Tabelle 7 zu entnehmen.
9. Das Einpressen der Radialdichtringe in das Gehäuse erfolgt am besten mit einer hydraulischen oder mechanischen Einpreßhilfe.

Radial-Wellendichtring Edelstahl mit PTFE-Dichtlippe

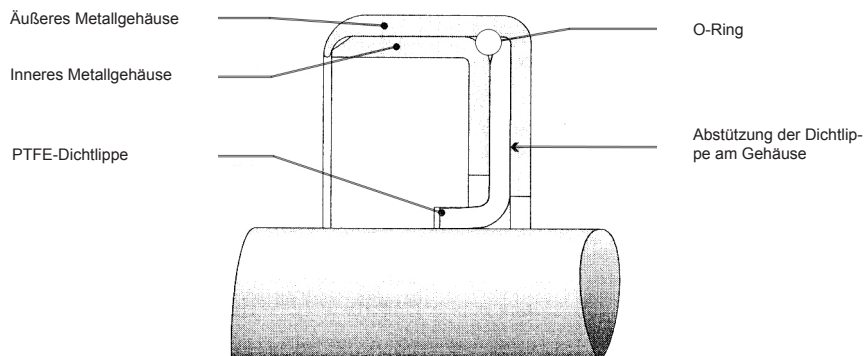

Einsatzgrenzen

- thermische Belastbarkeit von -130 °C bis $+200\text{ °C}$
- Im Vergleich zu Elastomeren „stick-slip“-freies Verhalten
- geeignet bei Mangelschmierung und Trockenlauf
- Umfangsgeschwindigkeit: bis max. 30 m/s (auch druckbelastbar, je nach Höhe der übrigen Betriebsbedingungen bis zu 1 MPo.)
- Bei gleichzeitigem Auftreten im Bereich der Höchstgrenzen sind Versuche zur Prüfung der Funktionssicherheit dringend zu empfehlen.

WELLENDICHTRING / OIL-SEAL

40/62/7 A ACM WELLENDICHTRING / OIL-SEAL
105/130/12 AS ACM WELLENDICHTRING / OIL-SEAL
115/140/12 AS ACM WELLENDICHTRING / OIL-SEAL
80/100/10 A EPDM WELLENDICHTRING / OIL-SEAL
170/200/12 AS EPDM FDA WELLENDICHTRING / OIL-SEAL
4/11/6 A NBR WELLENDICHTRING / OIL-SEAL
5/15/6 A NBR WELLENDICHTRING / OIL-SEAL*
5/16/6 A NBR WELLENDICHTRING / OIL-SEAL*
6/12/4,5 A NBR WELLENDICHTRING / OIL-SEAL
6/14/6 A NBR WELLENDICHTRING / OIL-SEAL
6/16/7 A NBR WELLENDICHTRING / OIL-SEAL*
6/19/6 A NBR WELLENDICHTRING / OIL-SEAL*
6/19/7 A NBR WELLENDICHTRING / OIL-SEAL*
6/22/7 A NBR WELLENDICHTRING / OIL-SEAL*
6/22/7 AS NBR WELLENDICHTRING / OIL-SEAL
7/16/7 A NBR WELLENDICHTRING / OIL-SEAL*
7/18/8 AS NBR WELLENDICHTRING / OIL-SEAL
7/22/7 A NBR WELLENDICHTRING / OIL-SEAL*
8/14/4 A NBR WELLENDICHTRING / OIL-SEAL
8/16/7 A NBR WELLENDICHTRING / OIL-SEAL*
8/16/7 AS NBR WELLENDICHTRING / OIL-SEAL*
8/16/7 AS NBR SSS WELLENDICHTRING / OIL-SEAL
8/16/8 AS NBR WELLENDICHTRING / OIL-SEAL
8/18/5 A NBR WELLENDICHTRING / OIL-SEAL
8/18/6 A NBR WELLENDICHTRING / OIL-SEAL
8/18/7 A NBR WELLENDICHTRING / OIL-SEAL
8/19/6,5 A NBR WELLENDICHTRING / OIL-SEAL
8/22/7 A NBR WELLENDICHTRING / OIL-SEAL*
8/22/7 AS NBR WELLENDICHTRING / OIL-SEAL*
8/22/7 AS-P NBR WELLENDICHTRING / OIL-SEAL*
8/24/7 A NBR WELLENDICHTRING / OIL-SEAL*
9/19/5 AS NBR WELLENDICHTRING / OIL-SEAL
9/20/6 AS-P NBR WELLENDICHTRING / OIL-SEAL*
9/22/7 A NBR WELLENDICHTRING / OIL-SEAL*
9/24/7 A NBR WELLENDICHTRING / OIL-SEAL
9/26/7 A NBR WELLENDICHTRING / OIL-SEAL
10/16/4 AS NBR WELLENDICHTRING / OIL-SEAL*
10/16/5 A NBR WELLENDICHTRING / OIL-SEAL
10/16/4 A NBR WELLENDICHTRING / OIL-SEAL*
10/18/4 AS NBR WELLENDICHTRING / OIL-SEAL*
10/19/7 A NBR WELLENDICHTRING / OIL-SEAL*
10/19/7 AS NBR WELLENDICHTRING / OIL-SEAL*
10/20/6 AS NBR WELLENDICHTRING / OIL-SEAL
10/20/6 AS-P NBR WELLENDICHTRING / OIL-SEAL*
10/20/7 AS NBR WELLENDICHTRING / OIL-SEAL
10/22/6 A NBR WELLENDICHTRING / OIL-SEAL*
10/22/6/6,5 AS-P NBR WELLENDICHTRING / OIL-SEAL*

10/22/7 A NBR WELLENDICHTRING / OIL-SEAL*
10/22/7 AS NBR WELLENDICHTRING / OIL-SEAL*
10/22/7 AS-P NBR WELLENDICHTRING / OIL-SEAL*
10/24/7 A NBR WELLENDICHTRING / OIL-SEAL*
10/24/7 AS NBR WELLENDICHTRING / OIL-SEAL*
10/26/7 A NBR WELLENDICHTRING / OIL-SEAL*
10/26/7 AS NBR WELLENDICHTRING / OIL-SEAL*
10/26/7/7,5 AS-P NBR WELLENDICHTRING / OIL-SEAL
10/28/7 AS NBR WELLENDICHTRING / OIL-SEAL
10/30/7 A NBR WELLENDICHTRING / OIL-SEAL*
11/22/7 A NBR WELLENDICHTRING / OIL-SEAL*
11/22/7 AS-P NBR WELLENDICHTRING / OIL-SEAL*
11/26/7 A NBR WELLENDICHTRING / OIL-SEAL*
11/30/7 AS NBR WELLENDICHTRING / OIL-SEAL
12/18/5 AS NBR WELLENDICHTRING / OIL-SEAL
12/19/5 A NBR WELLENDICHTRING / OIL-SEAL*
12/20/5 AS NBR WELLENDICHTRING / OIL-SEAL*
12/22/4 A NBR WELLENDICHTRING / OIL-SEAL*
12/22/5 A NBR WELLENDICHTRING / OIL-SEAL*
12/22/5 AS NBR WELLENDICHTRING / OIL-SEAL*
12/22/6 AS-P NBR WELLENDICHTRING / OIL-SEAL*
12/22/7 A NBR WELLENDICHTRING / OIL-SEAL*
12/22/7 AS NBR WELLENDICHTRING / OIL-SEAL*
12/22/7 AS-P NBR WELLENDICHTRING / OIL-SEAL*
12/24/6 AS NBR WELLENDICHTRING / OIL-SEAL
12/24/7 A NBR WELLENDICHTRING / OIL-SEAL*
12/24/7 A NBR SSS WELLENDICHTRING / OIL-SEAL
12/24/7 AS NBR WELLENDICHTRING / OIL-SEAL*
12/24/7 AS-P NBR WELLENDICHTRING / OIL-SEAL*
12/24/10 A-DUO NBR WELLENDICHTRING / OIL-SEAL
12/25/5 AS NBR WELLENDICHTRING / OIL-SEAL
12/25/7/8 AS NBR WELLENDICHTRING / OIL-SEAL
12/26/5 A NBR SSS WELLENDICHTRING / OIL-SEAL
12/26/7 A NBR WELLENDICHTRING / OIL-SEAL,
12/26/8 A NBR WELLENDICHTRING / OIL-SEAL*
12/28/7 A NBR WELLENDICHTRING / OIL-SEAL*
12/28/7 AS NBR WELLENDICHTRING / OIL-SEAL*
12/28/10 AS NBR WELLENDICHTRING / OIL-SEAL
12/30/7 A NBR WELLENDICHTRING / OIL-SEAL*
12/30/7 AS NBR WELLENDICHTRING / OIL-SEAL
12/32/7 A NBR WELLENDICHTRING / OIL-SEAL*
12/32/7 AS NBR WELLENDICHTRING / OIL-SEAL*
12/35/7 A NBR WELLENDICHTRING / OIL-SEAL
13/22/5 A NBR WELLENDICHTRING / OIL-SEAL*
13/35/10 A NBR WELLENDICHTRING / OIL-SEAL
14/22/4 A NBR WELLENDICHTRING / OIL-SEAL*
14/22/4 AS NBR WELLENDICHTRING / OIL-SEAL*
14/22/5 AS NBR WELLENDICHTRING / OIL-SEAL
14/22/6/6,5 AS-P NBR WELLENDICHTRING / OIL-SEAL
14/22/7 AS NBR WELLENDICHTRING / OIL-SEAL

14/24/5 AS NBR WELLENDICHTRING / OIL-SEAL *
14/24/7 A NBR WELLENDICHTRING / OIL-SEAL *
14/24/7 AS NBR WELLENDICHTRING / OIL-SEAL *
14/24/7 AS-P NBR WELLENDICHTRING / OIL-SEAL *
14/25/5 AS NBR WELLENDICHTRING / OIL-SEAL
14/25/7 AS NBR WELLENDICHTRING / OIL-SEAL
14/26/7 AS NBR WELLENDICHTRING / OIL-SEAL *
14/28/7 A NBR WELLENDICHTRING / OIL-SEAL *
14/28/7 AS NBR WELLENDICHTRING / OIL-SEAL
14/30/7 A NBR WELLENDICHTRING / OIL-SEAL *
14/35/7 A NBR WELLENDICHTRING / OIL-SEAL *
15/24/5 A NBR WELLENDICHTRING / OIL-SEAL *
15/24/5 AS NBR WELLENDICHTRING / OIL-SEAL *
15/24/7 A NBR WELLENDICHTRING / OIL-SEAL *
15/24/7 AS NBR WELLENDICHTRING / OIL-SEAL *
15/24/7 AS-P NBR WELLENDICHTRING / OIL-SEAL *
15/25/5 A NBR WELLENDICHTRING / OIL-SEAL *
15/25/5 AS NBR WELLENDICHTRING / OIL-SEAL
15/25/6/6,5 AS-P NBR WELLENDICHTRING / OIL-SEAL
15/25/7 AS NBR WELLENDICHTRING / OIL-SEAL *
15/25/7 AS-P NBR WELLENDICHTRING / OIL-SEAL *
15/26/7 AS-P NBR WELLENDICHTRING / OIL-SEAL
15/27/7 A NBR WELLENDICHTRING / OIL-SEAL *
15/28/4 A NBR WELLENDICHTRING / OIL-SEAL *
15/28/7 AS NBR WELLENDICHTRING / OIL-SEAL *
15/30/4,5 A NBR WELLENDICHTRING / OIL-SEAL *
15/30/7 A NBR WELLENDICHTRING / OIL-SEAL *
15/30/7 AS NBR WELLENDICHTRING / OIL-SEAL *
15/30/7/7,5 AS-P NBR WELLENDICHTRING / OIL-SEAL
15/30/8 AS NBR WELLENDICHTRING / OIL-SEAL
15/30/10 AS NBR WELLENDICHTRING / OIL-SEAL *
15/32/7 A NBR WELLENDICHTRING / OIL-SEAL *
15/32/7 AS NBR WELLENDICHTRING / OIL-SEAL *
15/35/6 AS-P NBR WELLENDICHTRING / OIL-SEAL *
15/35/7 A NBR WELLENDICHTRING / OIL-SEAL *
15/35/7 AS NBR WELLENDICHTRING / OIL-SEAL *
15/35/8 A NBR SSS WELLENDICHTRING / OIL-SEAL
15/35/10 A NBR WELLENDICHTRING / OIL-SEAL *
15/35/10 AS NBR WELLENDICHTRING / OIL-SEAL
15/40/7 AS NBR WELLENDICHTRING / OIL-SEAL
15/40/10 A NBR WELLENDICHTRING / OIL-SEAL *
15/40/10 AS NBR WELLENDICHTRING / OIL-SEAL
15/42/7 A NBR WELLENDICHTRING / OIL-SEAL *
16/24/4 A NBR WELLENDICHTRING / OIL-SEAL
16/24/4 AS NBR WELLENDICHTRING / OIL-SEAL
16/24/5 A NBR WELLENDICHTRING / OIL-SEAL *
16/24/5 AS NBR WELLENDICHTRING / OIL-SEAL
16/24/6 AS NBR WELLENDICHTRING / OIL-SEAL
16/26/7 A NBR WELLENDICHTRING / OIL-SEAL *
16/26/7/7,5 AS-P NBR WELLENDICHTRING / OIL-SEAL *

16/28/7 A NBR WELLENDICHTRING / OIL-SEAL*
16/28/7 A NBR SSS WELLENDICHTRING / OIL-SEAL
16/28/7 AS NBR WELLENDICHTRING / OIL-SEAL*
16/28/7 AS-P NBR WELLENDICHTRING / OIL-SEAL*
16/30/7 A NBR WELLENDICHTRING / OIL-SEAL*
16/30/7 AS NBR WELLENDICHTRING / OIL-SEAL*
16/32/7 A NBR WELLENDICHTRING / OIL-SEAL*
16/35/7 A NBR WELLENDICHTRING / OIL-SEAL*
17/25/4 A NBR WELLENDICHTRING / OIL-SEAL*
17/26/6 A NBR WELLENDICHTRING / OIL-SEAL*
17/28/6 A NBR WELLENDICHTRING / OIL-SEAL*
17/28/6 AS-P NBR WELLENDICHTRING / OIL-SEAL
17,48/28,58/6,35/7 AS-P NBR WELLENDICHTRING / OIL-SEAL
17/28/7 A NBR WELLENDICHTRING / OIL-SEAL*
17/28/7 AS NBR WELLENDICHTRING / OIL-SEAL*
17/28/7 AS-P NBR WELLENDICHTRING / OIL-SEAL*
17/30/5 AS NBR WELLENDICHTRING / OIL-SEAL*
17/30/6 AS-P NBR WELLENDICHTRING / OIL-SEAL*
17/30/7 A NBR WELLENDICHTRING / OIL-SEAL*
17/30/7 AS NBR WELLENDICHTRING / OIL-SEAL*
17/32/7 A NBR WELLENDICHTRING / OIL-SEAL*
17,5/32/7 AS NBR WELLENDICHTRING / OIL-SEAL
17/32/8 AS NBR WELLENDICHTRING / OIL-SEAL
17/35/7 A NBR WELLENDICHTRING / OIL-SEAL*
17/35/7 A-DUO NBR WELLENDICHTRING / OIL-SEAL
17/35/7 AS NBR WELLENDICHTRING / OIL-SEAL*
17/35/7 AS-P NBR WELLENDICHTRING / OIL-SEAL*
17/35/8 A NBR WELLENDICHTRING / OIL-SEAL*
17/35/8 AS NBR WELLENDICHTRING / OIL-SEAL*
17/35/10 AS NBR WELLENDICHTRING / OIL-SEAL
17/38/8 AS NBR WELLENDICHTRING / OIL-SEAL
17/40/7 A-DUO NBR WELLENDICHTRING / OIL-SEAL
17/40/7 AS NBR WELLENDICHTRING / OIL-SEAL*
17/40/10 AS NBR WELLENDICHTRING / OIL-SEAL
17/47/7 AS NBR WELLENDICHTRING / OIL-SEAL
17/47/8 AS NBR WELLENDICHTRING / OIL-SEAL
18/26/6 AS NBR WELLENDICHTRING / OIL-SEAL
18/28/6 AS NBR WELLENDICHTRING / OIL-SEAL
18/28/7 A NBR WELLENDICHTRING / OIL-SEAL*
18/28/7 AS NBR WELLENDICHTRING / OIL-SEAL*
18/28/7/7,5 AS-P NBR WELLENDICHTRING / OIL-SEAL
18/30/5 A NBR WELLENDICHTRING / OIL-SEAL*
18/30/5 AS NBR WELLENDICHTRING / OIL-SEAL
18/30/6/6,5 AS-P NBR WELLENDICHTRING / OIL-SEAL*
18/30/7 A NBR WELLENDICHTRING / OIL-SEAL*
18/30/7 A-DUO NBR WELLENDICHTRING / OIL-SEAL
18/30/7 AS-P NBR WELLENDICHTRING / OIL-SEAL*
18/32/6 AS NBR WELLENDICHTRING / OIL-SEAL
18/32/7 A NBR WELLENDICHTRING / OIL-SEAL*
18/32/7 AS NBR WELLENDICHTRING / OIL-SEAL*

18/35/6 AS-P NBR WELLENDICHTRING / OIL-SEAL*
18/35/7 A NBR WELLENDICHTRING / OIL-SEAL*
18/35/7 AS NBR WELLENDICHTRING / OIL-SEAL*
18/35/8 A NBR WELLENDICHTRING / OIL-SEAL
18/35/10 A NBR WELLENDICHTRING / OIL-SEAL*
18/40/7 A NBR WELLENDICHTRING / OIL-SEAL*
18/40/7 AS NBR WELLENDICHTRING / OIL-SEAL
19/27,2/5 AS-P NBR WELLENDICHTRING / OIL-SEAL
19/30/7 AS NBR WELLENDICHTRING / OIL-SEAL*
19/32/7 AS NBR WELLENDICHTRING / OIL-SEAL*
19/35/7 AS NBR WELLENDICHTRING / OIL-SEAL*
19/42/7 AS NBR WELLENDICHTRING / OIL-SEAL
20/26/4 AS NBR WELLENDICHTRING / OIL-SEAL
20/28/4 AS NBR WELLENDICHTRING / OIL-SEAL
20/28/6 AS NBR WELLENDICHTRING / OIL-SEAL*
20/28/7 AS NBR WELLENDICHTRING / OIL-SEAL
20/30/5 A NBR WELLENDICHTRING / OIL-SEAL*
20/30/5 AS NBR WELLENDICHTRING / OIL-SEAL*
20/30/5 AS-P NBR WELLENDICHTRING / OIL-SEAL*
20/30/7 A NBR WELLENDICHTRING / OIL-SEAL*
20/30/7 A NBR SSS WELLENDICHTRING / OIL-SEAL
20/30/7 AS NBR WELLENDICHTRING / OIL-SEAL*
20/30/7 AS-P NBR WELLENDICHTRING / OIL-SEAL*
20/32/5 AS NBR WELLENDICHTRING / OIL-SEAL
20/32/7 A NBR WELLENDICHTRING / OIL-SEAL*
20/32/7 AS NBR WELLENDICHTRING / OIL-SEAL*
20/35/6 A NBR WELLENDICHTRING / OIL-SEAL
20/35/7 A NBR WELLENDICHTRING / OIL-SEAL*
20/35/7 AS NBR WELLENDICHTRING / OIL-SEAL*
20/35/7 AS NBR SSS WELLENDICHTRING / OIL-SEAL
20/35/10 A NBR WELLENDICHTRING / OIL-SEAL*
20/36/7 AS NBR WELLENDICHTRING / OIL-SEAL
20/37/7 A NBR WELLENDICHTRING / OIL-SEAL
20/37/7 AS NBR WELLENDICHTRING / OIL-SEAL
20/38/7 A NBR WELLENDICHTRING / OIL-SEAL*
20/40/6 A NBR WELLENDICHTRING / OIL-SEAL
20/40/7 A NBR WELLENDICHTRING / OIL-SEAL*
20/40/7 A NBR SSS WELLENDICHTRING / OIL-SEAL
20/40/7 AS NBR WELLENDICHTRING / OIL-SEAL*
20/40/10 A NBR WELLENDICHTRING / OIL-SEAL*
20/40/10 AS NBR WELLENDICHTRING / OIL-SEAL*
20/42/6 AS NBR WELLENDICHTRING / OIL-SEAL*
20/42/7 A NBR WELLENDICHTRING / OIL-SEAL*
20/42/7 AS NBR WELLENDICHTRING / OIL-SEAL*
20/42/10 A NBR WELLENDICHTRING / OIL-SEAL*
20/47/7 A NBR WELLENDICHTRING / OIL-SEAL*
20/47/7 AS NBR WELLENDICHTRING / OIL-SEAL*
20/47/8 AS NBR WELLENDICHTRING / OIL-SEAL
20/47/10 A NBR WELLENDICHTRING / OIL-SEAL*
20/47/10 AS NBR WELLENDICHTRING / OIL-SEAL*

20/48/10 AS NBR WELLENDICHTRING / OIL-SEAL
20/52/7 AS NBR WELLENDICHTRING / OIL-SEAL*
20/52/8 AS NBR WELLENDICHTRING / OIL-SEAL
20/52/10 AS NBR WELLENDICHTRING / OIL-SEAL*
22/28/4 AS NBR WELLENDICHTRING / OIL-SEAL
22/30/7 A NBR WELLENDICHTRING / OIL-SEAL
22/32/5,5 A NBR WELLENDICHTRING / OIL-SEAL*
22/32/6/6,5 AS-P NBR WELLENDICHTRING / OIL-SEAL
22/32/7 A NBR WELLENDICHTRING / OIL-SEAL*
22/32/7 AS NBR WELLENDICHTRING / OIL-SEAL*
22/32/7 AS-P NBR WELLENDICHTRING / OIL-SEAL*
22/35/6 A NBR WELLENDICHTRING / OIL-SEAL
22/35/6/6,5 AS-P NBR WELLENDICHTRING / OIL-SEAL*
22/35/6,5 AS NBR WELLENDICHTRING / OIL-SEAL
22/35/7 A NBR WELLENDICHTRING / OIL-SEAL*
22/35/7 AS NBR WELLENDICHTRING / OIL-SEAL*
22/35/10 AS NBR WELLENDICHTRING / OIL-SEAL
22/37/7 AS NBR WELLENDICHTRING / OIL-SEAL
22/40/7 A NBR WELLENDICHTRING / OIL-SEAL*
22/40/7 AS NBR WELLENDICHTRING / OIL-SEAL*
22/40/8 AS NBR WELLENDICHTRING / OIL-SEAL
22/40/10 AS NBR WELLENDICHTRING / OIL-SEAL*
22/45/7 AS NBR WELLENDICHTRING / OIL-SEAL
22/47/7 A NBR WELLENDICHTRING / OIL-SEAL*
22/47/7 AS NBR WELLENDICHTRING / OIL-SEAL
22/47/10 AS NBR WELLENDICHTRING / OIL-SEAL
24/32/7 AS NBR WELLENDICHTRING / OIL-SEAL
24/35/7 A NBR WELLENDICHTRING / OIL-SEAL*
24/35/7 AS NBR WELLENDICHTRING / OIL-SEAL*
24/36/7 AS NBR WELLENDICHTRING / OIL-SEAL*
24/37/7 A NBR WELLENDICHTRING / OIL-SEAL*
24/37/7 AS NBR WELLENDICHTRING / OIL-SEAL
24/40/7 A NBR WELLENDICHTRING / OIL-SEAL*
24/40/7 AS NBR WELLENDICHTRING / OIL-SEAL*
24/40/7/7,5 AS-P NBR WELLENDICHTRING / OIL-SEAL*
24,5/40/8,5 A NBR WELLENDICHTRING / OIL-SEAL
24/42/8 AS NBR WELLENDICHTRING / OIL-SEAL
24/42/10 AS NBR WELLENDICHTRING / OIL-SEAL
24/45/10 AS NBR WELLENDICHTRING / OIL-SEAL
24/47/7 A NBR WELLENDICHTRING / OIL-SEAL*
24/47/10 A NBR WELLENDICHTRING / OIL-SEAL
24/47/10 AS NBR WELLENDICHTRING / OIL-SEAL
24/52/7 AS NBR WELLENDICHTRING / OIL-SEAL
25/32/6 AS NBR WELLENDICHTRING / OIL-SEAL
25/32/7 A NBR WELLENDICHTRING / OIL-SEAL*
25/33/6 A NBR WELLENDICHTRING / OIL-SEAL
25/35/5 A NBR WELLENDICHTRING / OIL-SEAL
25/35/6 AS-P NBR WELLENDICHTRING / OIL-SEAL*
25/35/7 A NBR WELLENDICHTRING / OIL-SEAL*
25/35/7 AS NBR WELLENDICHTRING / OIL-SEAL*

25/35/10 AS NBR WELLENDICHTRING / OIL-SEAL
25/36/7 AS NBR WELLENDICHTRING / OIL-SEAL
25/37/5 A NBR WELLENDICHTRING / OIL-SEAL*
25/37/6/6,5 AS-P NBR WELLENDICHTRING / OIL-SEAL
25/37/7 A NBR WELLENDICHTRING / OIL-SEAL
25/37/7 AS NBR WELLENDICHTRING / OIL-SEAL*
25/38/7 A NBR WELLENDICHTRING / OIL-SEAL*
25/38/7 AS NBR WELLENDICHTRING / OIL-SEAL*
25/40/5 A NBR WELLENDICHTRING / OIL-SEAL
25/40/5 AS NBR WELLENDICHTRING / OIL-SEAL
25/40/7 A NBR WELLENDICHTRING / OIL-SEAL*
25/40/7 AS NBR WELLENDICHTRING / OIL-SEAL*
25/40/7 AS-P NBR WELLENDICHTRING / OIL-SEAL*
25/40/8 AS NBR WELLENDICHTRING / OIL-SEAL*
25/40/10 A NBR WELLENDICHTRING / OIL-SEAL*
25/40/10 AS NBR WELLENDICHTRING / OIL-SEAL
25/42/6 A NBR WELLENDICHTRING / OIL-SEAL*
25/42/6/6,5 AS-P NBR WELLENDICHTRING / OIL-SEAL*
25/42/7 A NBR WELLENDICHTRING / OIL-SEAL*
25/42/7 AS NBR WELLENDICHTRING / OIL-SEAL*
25/42/8 AS NBR WELLENDICHTRING / OIL-SEAL
25/42/10 A NBR WELLENDICHTRING / OIL-SEAL*
25/42/10 AS NBR WELLENDICHTRING / OIL-SEAL*
25/45/7 AS NBR WELLENDICHTRING / OIL-SEAL*
25/45/10 A NBR WELLENDICHTRING / OIL-SEAL*
25/45/10 AS NBR WELLENDICHTRING / OIL-SEAL*
25/46/7 A NBR WELLENDICHTRING / OIL-SEAL*
25/46/7 AS NBR WELLENDICHTRING / OIL-SEAL
25/47/6 AS-P NBR WELLENDICHTRING / OIL-SEAL*
25/47/7 A NBR WELLENDICHTRING / OIL-SEAL*
25/47/7 A NBR SSS WELLENDICHTRING / OIL-SEAL
25/47/7 AS NBR WELLENDICHTRING / OIL-SEAL*
25/47/8 AS NBR WELLENDICHTRING / OIL-SEAL
25/47/10 A NBR WELLENDICHTRING / OIL-SEAL*
25/47/10 AS NBR WELLENDICHTRING / OIL-SEAL*
25/50/10 AS NBR WELLENDICHTRING / OIL-SEAL*
25/52/5 A NBR WELLENDICHTRING / OIL-SEAL
25/52/7 A NBR WELLENDICHTRING / OIL-SEAL*
25/52/7 A NBR SSS WELLENDICHTRING / OIL-SEAL
25/52/7 AS NBR WELLENDICHTRING / OIL-SEAL*
25/52/8 A NBR WELLENDICHTRING / OIL-SEAL*
25/52/10 A NBR WELLENDICHTRING / OIL-SEAL*
25/52/10 AS NBR WELLENDICHTRING / OIL-SEAL*
25/55/8 AS NBR WELLENDICHTRING / OIL-SEAL
25/62/7 AS NBR WELLENDICHTRING / OIL-SEAL*
25/62/10 A NBR WELLENDICHTRING / OIL-SEAL*
25/62/10 AS NBR WELLENDICHTRING / OIL-SEAL*
26/34/4 AS NBR WELLENDICHTRING / OIL-SEAL
26/35/7 A NBR WELLENDICHTRING / OIL-SEAL*
26/36/7 A NBR WELLENDICHTRING / OIL-SEAL

26/37/7 A NBR WELLENDICHTRING / OIL-SEAL*
26/37/7 AS NBR WELLENDICHTRING / OIL-SEAL*
26/37/7/7,5 AS-P NBR WELLENDICHTRING / OIL-SEAL
26/38/7 AS NBR WELLENDICHTRING / OIL-SEAL
26/42/7 A NBR WELLENDICHTRING / OIL-SEAL*
26/42/7 AS NBR WELLENDICHTRING / OIL-SEAL*
26/47/7 A NBR WELLENDICHTRING / OIL-SEAL*
26/47/7 AS NBR WELLENDICHTRING / OIL-SEAL
26/47/10 AS NBR WELLENDICHTRING / OIL-SEAL
26/52/10 AS NBR WELLENDICHTRING / OIL-SEAL*
27/37/7 A NBR WELLENDICHTRING / OIL-SEAL*
27/40/7 AS NBR WELLENDICHTRING / OIL-SEAL
27/40/8 AS NBR WELLENDICHTRING / OIL-SEAL
27/42/7 AS-P NBR WELLENDICHTRING / OIL-SEAL*
27/47/7 AS NBR WELLENDICHTRING / OIL-SEAL
27/47/10 AS NBR WELLENDICHTRING / OIL-SEAL
27/52/5 AS NBR WELLENDICHTRING / OIL-SEAL
27/53/7 AS NBR WELLENDICHTRING / OIL-SEAL
28/37/4 AS NBR WELLENDICHTRING / OIL-SEAL
28/38/7 A NBR WELLENDICHTRING / OIL-SEAL*
28/38/7 AS NBR WELLENDICHTRING / OIL-SEAL*
28/40/6/6,5 AS-P NBR WELLENDICHTRING / OIL-SEAL
28/40/7 A NBR WELLENDICHTRING / OIL-SEAL*
28/40/7 AS NBR WELLENDICHTRING / OIL-SEAL*
28/40/7 AS-P NBR WELLENDICHTRING / OIL-SEAL*
28/40/8 A-DUO NBR WELLENDICHTRING / OIL-SEAL
28/40/8 AS NBR WELLENDICHTRING / OIL-SEAL
28/40/8/8,5 AS-P NBR WELLENDICHTRING / OIL-SEAL
28/40/10 A NBR WELLENDICHTRING / OIL-SEAL
28,5/42/5/6 AS-P NBR WELLENDICHTRING / OIL-SEAL
28/42/7 AS NBR WELLENDICHTRING / OIL-SEAL*
28/42/8 AS NBR WELLENDICHTRING / OIL-SEAL
28/42/10 A NBR WELLENDICHTRING / OIL-SEAL*
28/42/10 AS NBR WELLENDICHTRING / OIL-SEAL
28/45/7 AS NBR WELLENDICHTRING / OIL-SEAL
28/45/8 AS NBR WELLENDICHTRING / OIL-SEAL
28/47/7 A NBR WELLENDICHTRING / OIL-SEAL*
28/47/7 AS NBR WELLENDICHTRING / OIL-SEAL*
28/47/10 A NBR WELLENDICHTRING / OIL-SEAL*
28/47/10 AS NBR WELLENDICHTRING / OIL-SEAL
28/48/7 AS NBR WELLENDICHTRING / OIL-SEAL
28/50/10 A NBR WELLENDICHTRING / OIL-SEAL*
28/50/10 AS NBR WELLENDICHTRING / OIL-SEAL
28/52/7 A NBR WELLENDICHTRING / OIL-SEAL*
28/52/7 AS NBR WELLENDICHTRING / OIL-SEAL
28/52/10 AS NBR WELLENDICHTRING / OIL-SEAL*
28/56/10 AS NBR WELLENDICHTRING / OIL-SEAL
29/40/7 A NBR WELLENDICHTRING / OIL-SEAL
29/50/8 AS NBR WELLENDICHTRING / OIL-SEAL
29/50/10 AS NBR WELLENDICHTRING / OIL-SEAL

30/40/5 A NBR WELLENDICHTRING / OIL-SEAL*
30/40/7 A NBR WELLENDICHTRING / OIL-SEAL*
30/40/7 A NBR SSS WELLENDICHTRING / OIL-SEAL
30/40/7 AS NBR WELLENDICHTRING / OIL-SEAL*
30/40/7 AS-P NBR WELLENDICHTRING / OIL-SEAL*
30/42/6 AS-P NBR WELLENDICHTRING / OIL-SEAL*
30/42/7 A NBR WELLENDICHTRING / OIL-SEAL*
30/42/7 AS NBR WELLENDICHTRING / OIL-SEAL*
30/42/8 AS NBR WELLENDICHTRING / OIL-SEAL*
30/42/10 AS NBR WELLENDICHTRING / OIL-SEAL
30/44/7 AS NBR WELLENDICHTRING / OIL-SEAL*
30/44/10 A NBR WELLENDICHTRING / OIL-SEAL*
30/45/5 AS NBR WELLENDICHTRING / OIL-SEAL
30/45/7 A NBR WELLENDICHTRING / OIL-SEAL*
30/45/7 AS NBR WELLENDICHTRING / OIL-SEAL*
30/45/8 A NBR WELLENDICHTRING / OIL-SEAL*
30/45/8 AS NBR WELLENDICHTRING / OIL-SEAL*
30/45/10 A NBR WELLENDICHTRING / OIL-SEAL
30/46/7 AS NBR WELLENDICHTRING / OIL-SEAL*
30/47/6 A NBR WELLENDICHTRING / OIL-SEAL*
30/47/7 A NBR WELLENDICHTRING / OIL-SEAL*
30/47/7 AS NBR WELLENDICHTRING / OIL-SEAL*
30/47/7 AS-P NBR WELLENDICHTRING / OIL-SEAL*
30/47/8 A NBR WELLENDICHTRING / OIL-SEAL
30/47/8 AS NBR WELLENDICHTRING / OIL-SEAL*
30/47/8/8,5 AS-P NBR WELLENDICHTRING / OIL-SEAL
30/47/10 A NBR WELLENDICHTRING / OIL-SEAL*
30/47/10 AS NBR WELLENDICHTRING / OIL-SEAL*
30/48/5/5,5 AS-P NBR WELLENDICHTRING / OIL-SEAL
30/48/8 A NBR WELLENDICHTRING / OIL-SEAL
30/48/8 AS NBR WELLENDICHTRING / OIL-SEAL
30/50/5 A NBR WELLENDICHTRING / OIL-SEAL*
30/50/7 A NBR WELLENDICHTRING / OIL-SEAL*
30/50/7 AS NBR WELLENDICHTRING / OIL-SEAL
30/50/7 AS-P NBR WELLENDICHTRING / OIL-SEAL*
30/50/8 AS NBR WELLENDICHTRING / OIL-SEAL*
30/50/10 A NBR WELLENDICHTRING / OIL-SEAL*
30/50/10 AS NBR WELLENDICHTRING / OIL-SEAL*
30/52/4 A NBR WELLENDICHTRING / OIL-SEAL
30/52/7 A NBR WELLENDICHTRING / OIL-SEAL*
30/52/7 AS NBR WELLENDICHTRING / OIL-SEAL*
30/52/7/7,5 AS-P NBR WELLENDICHTRING / OIL-SEAL
30/52/8 AS NBR WELLENDICHTRING / OIL-SEAL
30/52/10 A NBR WELLENDICHTRING / OIL-SEAL*
30/52/10 AS NBR WELLENDICHTRING / OIL-SEAL*
30/52/12 AS NBR WELLENDICHTRING / OIL-SEAL
30/55/7 A NBR WELLENDICHTRING / OIL-SEAL*
30/55/7 AS NBR WELLENDICHTRING / OIL-SEAL*
30/55/7/7,5 AS-P NBR WELLENDICHTRING / OIL-SEAL
30/55/10 A NBR WELLENDICHTRING / OIL-SEAL*

30/55/10 A NBR SSS WELLENDICHTRING / OIL-SEAL
30/55/10 AS NBR WELLENDICHTRING / OIL-SEAL*
30/56/10 AS NBR WELLENDICHTRING / OIL-SEAL
30/60/10 A NBR WELLENDICHTRING / OIL-SEAL*
30/62/7 A NBR WELLENDICHTRING / OIL-SEAL*
30/62/7 AS NBR WELLENDICHTRING / OIL-SEAL*
30/62/7/7,5 AS-P NBR WELLENDICHTRING / OIL-SEAL
30/62/8 AS NBR WELLENDICHTRING / OIL-SEAL
30/62/10 A NBR WELLENDICHTRING / OIL-SEAL*
30/62/10 AS NBR WELLENDICHTRING / OIL-SEAL*
30/68/7 A NBR WELLENDICHTRING / OIL-SEAL
30/68/10 AS NBR WELLENDICHTRING / OIL-SEAL
30/72/8/8,5 AS-P NBR WELLENDICHTRING / OIL-SEAL
30/72/10 A NBR WELLENDICHTRING / OIL-SEAL*
30/72/10 AS NBR WELLENDICHTRING / OIL-SEAL*
30/90/7 AS NBR WELLENDICHTRING / OIL-SEAL
31/42/8 AX7 NBR WELLENDICHTRING / OIL-SEAL,
32/42/7 A NBR WELLENDICHTRING / OIL-SEAL*
32/42/7 AS NBR WELLENDICHTRING / OIL-SEAL*
32/42/8 AS NBR WELLENDICHTRING / OIL-SEAL
32/44/7 AS-P NBR WELLENDICHTRING / OIL-SEAL*
32/44/8 AS NBR WELLENDICHTRING / OIL-SEAL
32/45/7 A NBR WELLENDICHTRING / OIL-SEAL*
32/45/7 AS NBR WELLENDICHTRING / OIL-SEAL*
32/45/7 AS-P NBR WELLENDICHTRING / OIL-SEAL*
32/45/8 AS NBR WELLENDICHTRING / OIL-SEAL
32/45/10 AS NBR WELLENDICHTRING / OIL-SEAL
32/47/6/6,5 AS-P NBR WELLENDICHTRING / OIL-SEAL
32/47/7 A NBR WELLENDICHTRING / OIL-SEAL*
32/47/7 AS NBR WELLENDICHTRING / OIL-SEAL*
32/47/7 AS-P NBR WELLENDICHTRING / OIL-SEAL*
32/47/10 AS NBR WELLENDICHTRING / OIL-SEAL*
32/48/8 AS NBR WELLENDICHTRING / OIL-SEAL
32/50/8 A NBR WELLENDICHTRING / OIL-SEAL*
32/50/10 A NBR WELLENDICHTRING / OIL-SEAL*
32/50/10 AS NBR WELLENDICHTRING / OIL-SEAL
32/52/5 A NBR WELLENDICHTRING / OIL-SEAL
32/52/6 AS NBR WELLENDICHTRING / OIL-SEAL
32/52/7 A NBR WELLENDICHTRING / OIL-SEAL*
32/52/7 AS NBR WELLENDICHTRING / OIL-SEAL*
32/52/8 AS NBR WELLENDICHTRING / OIL-SEAL
32/52/10 AS NBR WELLENDICHTRING / OIL-SEAL*
32/55/10 A NBR WELLENDICHTRING / OIL-SEAL
32/55/10 AS NBR WELLENDICHTRING / OIL-SEAL
32/56/10 AS NBR WELLENDICHTRING / OIL-SEAL
32/62/8 AS NBR WELLENDICHTRING / OIL-SEAL
32/62/10 AS NBR WELLENDICHTRING / OIL-SEAL
32/72/10 AS NBR WELLENDICHTRING / OIL-SEAL
33/50/10 AS NBR WELLENDICHTRING / OIL-SEAL
34/44/7 AS NBR WELLENDICHTRING / OIL-SEAL

34/45/7 AS NBR WELLENDICHTRING / OIL-SEAL
34/46/10 A NBR WELLENDICHTRING / OIL-SEAL
34/47/7 AS NBR WELLENDICHTRING / OIL-SEAL
34/48/8 AS NBR WELLENDICHTRING / OIL-SEAL
34/50/10 A NBR WELLENDICHTRING / OIL-SEAL*
34/52/8 AS NBR WELLENDICHTRING / OIL-SEAL
34/52/10 A NBR WELLENDICHTRING / OIL-SEAL*
35/42/4 AS NBR WELLENDICHTRING / OIL-SEAL
35/45/7 A NBR WELLENDICHTRING / OIL-SEAL*
35/45/7 AS NBR WELLENDICHTRING / OIL-SEAL*
35/45/8 AS NBR WELLENDICHTRING / OIL-SEAL
35/45/10 A NBR WELLENDICHTRING / OIL-SEAL*
35/47/6/6,5 AS-P NBR WELLENDICHTRING / OIL-SEAL*
35/47/7 A NBR WELLENDICHTRING / OIL-SEAL*
35/47/7 AS NBR WELLENDICHTRING / OIL-SEAL*
35/47/7 AS-P NBR WELLENDICHTRING / OIL-SEAL*
35/47/10 AS-P NBR WELLENDICHTRING / OIL-SEAL*
35/48/7 AS NBR WELLENDICHTRING / OIL-SEAL*
35/48/8 AS NBR WELLENDICHTRING / OIL-SEAL*
35/50/7 A NBR WELLENDICHTRING / OIL-SEAL*
35/50/7 AS NBR WELLENDICHTRING / OIL-SEAL*
35/50/7 AS-P NBR WELLENDICHTRING / OIL-SEAL*
35/50/8 AS NBR WELLENDICHTRING / OIL-SEAL*
35/50/10 A NBR WELLENDICHTRING / OIL-SEAL*
35/50/10 AS NBR WELLENDICHTRING / OIL-SEAL*
35/52/6 AS NBR WELLENDICHTRING / OIL-SEAL*
35/52/6/6,5 AS-P NBR WELLENDICHTRING / OIL-SEAL*
35/52/7 A NBR WELLENDICHTRING / OIL-SEAL*
35/52/7 AS NBR WELLENDICHTRING / OIL-SEAL*
35/52/7/7,5 AS-P NBR WELLENDICHTRING / OIL-SEAL
35/52/8 A NBR WELLENDICHTRING / OIL-SEAL
35/52/8 AS NBR WELLENDICHTRING / OIL-SEAL
35/52/10 A NBR WELLENDICHTRING / OIL-SEAL*
35/52/10 AS NBR WELLENDICHTRING / OIL-SEAL*
35/54/6/6,5 AS-P NBR WELLENDICHTRING / OIL-SEAL
35/54/10 AS NBR WELLENDICHTRING / OIL-SEAL
35/55/7 AS NBR WELLENDICHTRING / OIL-SEAL*
35/55/8 A NBR WELLENDICHTRING / OIL-SEAL*
35/55/8 AS NBR WELLENDICHTRING / OIL-SEAL*
35/55/9 AS NBR WELLENDICHTRING / OIL-SEAL*
35/55/10 A NBR WELLENDICHTRING / OIL-SEAL*
35/55/10 AS NBR WELLENDICHTRING / OIL-SEAL*
35/55/12 AS NBR WELLENDICHTRING / OIL-SEAL
35/56/10 A NBR WELLENDICHTRING / OIL-SEAL*
35/56/10 AS NBR WELLENDICHTRING / OIL-SEAL*
35/56/12 A NBR WELLENDICHTRING / OIL-SEAL
35/58/10 AS NBR WELLENDICHTRING / OIL-SEAL*
35/60/10 A NBR WELLENDICHTRING / OIL-SEAL*
35/60/10 AS NBR WELLENDICHTRING / OIL-SEAL
35/62/7 A NBR WELLENDICHTRING / OIL-SEAL*

35/62/7 AS NBR WELLENDICHTRING / OIL-SEAL *
35/62/7 AS-P NBR WELLENDICHTRING / OIL-SEAL *
35/62/8 AS NBR WELLENDICHTRING / OIL-SEAL *
35/62/10 A NBR WELLENDICHTRING / OIL-SEAL *
35/62/10 AS NBR WELLENDICHTRING / OIL-SEAL *
35/62/12 AS NBR WELLENDICHTRING / OIL-SEAL *
35/65/10 A NBR WELLENDICHTRING / OIL-SEAL
35/65/10 AS NBR WELLENDICHTRING / OIL-SEAL
35/65/12 AS NBR WELLENDICHTRING / OIL-SEAL
35/67/7 A NBR WELLENDICHTRING / OIL-SEAL
35/68/10 AS NBR WELLENDICHTRING / OIL-SEAL *
35/72/7 A NBR WELLENDICHTRING / OIL-SEAL
35/72/7 AS NBR WELLENDICHTRING / OIL-SEAL *
35/72/8 AS NBR WELLENDICHTRING / OIL-SEAL
35/72/10 A NBR WELLENDICHTRING / OIL-SEAL *
35/72/10 AS NBR WELLENDICHTRING / OIL-SEAL *
35/72/12 AS NBR WELLENDICHTRING / OIL-SEAL *
35/80/10 A NBR WELLENDICHTRING / OIL-SEAL *
35/80/10 AS NBR WELLENDICHTRING / OIL-SEAL *
35/80/13 AS NBR WELLENDICHTRING / OIL-SEAL
35/100/12/12,5 AS-P NBR WELLENDICHTRING / OIL-SEAL
36/47/7 A NBR WELLENDICHTRING / OIL-SEAL *
36/47/7 AS NBR WELLENDICHTRING / OIL-SEAL *
36/50/7 A NBR WELLENDICHTRING / OIL-SEAL *
36/50/7 AS NBR WELLENDICHTRING / OIL-SEAL
36/50/8 AS NBR WELLENDICHTRING / OIL-SEAL
36/50/10 A NBR WELLENDICHTRING / OIL-SEAL
36/52/7 A NBR WELLENDICHTRING / OIL-SEAL *
36/52/7 AS NBR WELLENDICHTRING / OIL-SEAL *
36/52/10 AS NBR WELLENDICHTRING / OIL-SEAL
36/54/11 AS NBR WELLENDICHTRING / OIL-SEAL
36/58/10 AS NBR WELLENDICHTRING / OIL-SEAL
36/62/7 A NBR WELLENDICHTRING / OIL-SEAL *
37/52/8 AS NBR WELLENDICHTRING / OIL-SEAL *
37/62/8 AS NBR WELLENDICHTRING / OIL-SEAL *
38/50/6 AS-P NBR WELLENDICHTRING / OIL-SEAL *
38/50/7 A NBR WELLENDICHTRING / OIL-SEAL *
38/50/7 AS NBR WELLENDICHTRING / OIL-SEAL *
38/50/10 AS NBR WELLENDICHTRING / OIL-SEAL
38/52/7 A NBR WELLENDICHTRING / OIL-SEAL *
38/52/7 AS NBR WELLENDICHTRING / OIL-SEAL *
38/52/8 AS NBR WELLENDICHTRING / OIL-SEAL
38/52/10 AS NBR WELLENDICHTRING / OIL-SEAL *
38/54/10 AS NBR WELLENDICHTRING / OIL-SEAL *
38/55/7 A NBR WELLENDICHTRING / OIL-SEAL *
38/55/7 AS NBR WELLENDICHTRING / OIL-SEAL *
38/56/10 AS NBR WELLENDICHTRING / OIL-SEAL *
38/58/7 AS NBR WELLENDICHTRING / OIL-SEAL
38/58/10 AS NBR WELLENDICHTRING / OIL-SEAL
38/60/10 AS NBR WELLENDICHTRING / OIL-SEAL *

38/62/7 A NBR WELLENDICHTRING / OIL-SEAL*
38/62/7 AS NBR WELLENDICHTRING / OIL-SEAL*
38/62/7 AS-P NBR WELLENDICHTRING / OIL-SEAL*
38/62/10 A NBR WELLENDICHTRING / OIL-SEAL*
38/62/10 AS NBR WELLENDICHTRING / OIL-SEAL*
38/70/10 AS NBR WELLENDICHTRING / OIL-SEAL
38/72/10 A NBR WELLENDICHTRING / OIL-SEAL*
38/72/10 AS NBR WELLENDICHTRING / OIL-SEAL*
40/50/4 AS NBR WELLENDICHTRING / OIL-SEAL
40/50/7 AS NBR WELLENDICHTRING / OIL-SEAL*
40/50/8 A NBR WELLENDICHTRING / OIL-SEAL
40/52/6 AS NBR WELLENDICHTRING / OIL-SEAL
40/52/7 A NBR WELLENDICHTRING / OIL-SEAL*
40/52/7 AS NBR WELLENDICHTRING / OIL-SEAL*
40/52/7 AS-P NBR WELLENDICHTRING / OIL-SEAL*
40/52/10 AS NBR WELLENDICHTRING / OIL-SEAL*
40/55/6/6,5 AS-P NBR WELLENDICHTRING / OIL-SEAL
40/55/7 A NBR WELLENDICHTRING / OIL-SEAL*
40/55/7 A NBR SSS WELLENDICHTRING / OIL-SEAL
40/55/7 AS NBR WELLENDICHTRING / OIL-SEAL*
40/55/7/7,5 AS-P NBR WELLENDICHTRING / OIL-SEAL*
40/55/8 A NBR WELLENDICHTRING / OIL-SEAL*
40/55/8 AS NBR WELLENDICHTRING / OIL-SEAL*
40/55/10 A NBR WELLENDICHTRING / OIL-SEAL
40/55/10 AS NBR WELLENDICHTRING / OIL-SEAL*
40/56/6 AS-P NBR WELLENDICHTRING / OIL-SEAL*
40/56/7 AS NBR WELLENDICHTRING / OIL-SEAL
40/56/8 A NBR WELLENDICHTRING / OIL-SEAL*
40/56/8 AS NBR WELLENDICHTRING / OIL-SEAL*
40/56/10 AS NBR WELLENDICHTRING / OIL-SEAL
40/57/10 AS NBR WELLENDICHTRING / OIL-SEAL
40/58/10 A NBR WELLENDICHTRING / OIL-SEAL*
40/58/10 AS NBR WELLENDICHTRING / OIL-SEAL*
40/60/7/7,5 AS-P NBR WELLENDICHTRING / OIL-SEAL*
40/60/8 AS NBR WELLENDICHTRING / OIL-SEAL*
40/60/10 A NBR WELLENDICHTRING / OIL-SEAL*
40/60/10 AS NBR WELLENDICHTRING / OIL-SEAL*
40/60/10 AS-P NBR WELLENDICHTRING / OIL-SEAL*
40/62/6 AS-P NBR WELLENDICHTRING / OIL-SEAL*
40/62/6 AS-P NBR SSS WELLENDICHTRING / OIL-SEAL
40/62/7 A NBR WELLENDICHTRING / OIL-SEAL*
40/62/7 AS NBR WELLENDICHTRING / OIL-SEAL*
40/62/8 A NBR WELLENDICHTRING / OIL-SEAL
40/62/8 AS NBR WELLENDICHTRING / OIL-SEAL*
40/62/10 A NBR WELLENDICHTRING / OIL-SEAL*
40/62/10 AS NBR WELLENDICHTRING / OIL-SEAL*
40/62/12 A NBR WELLENDICHTRING / OIL-SEAL
40/65/8 AS NBR WELLENDICHTRING / OIL-SEAL
40/65/10 A NBR WELLENDICHTRING / OIL-SEAL*
40/65/10 AS NBR WELLENDICHTRING / OIL-SEAL*

40/68/7 AS NBR WELLENDICHTRING / OIL-SEAL
40/68/8 A NBR WELLENDICHTRING / OIL-SEAL*
40/68/8 AS NBR WELLENDICHTRING / OIL-SEAL*
40/68/10 A NBR WELLENDICHTRING / OIL-SEAL*
40/68/10 AS NBR WELLENDICHTRING / OIL-SEAL*
40/68/12 AS NBR WELLENDICHTRING / OIL-SEAL
40/70/8 AS NBR WELLENDICHTRING / OIL-SEAL
40/70/10 A NBR WELLENDICHTRING / OIL-SEAL*
40/72/7 A NBR WELLENDICHTRING / OIL-SEAL*
40/72/7 AS NBR WELLENDICHTRING / OIL-SEAL*
40/72/10 A NBR WELLENDICHTRING / OIL-SEAL*
40/72/10 AS NBR WELLENDICHTRING / OIL-SEAL*
40/75/10 AS NBR WELLENDICHTRING / OIL-SEAL
40/80/7 AS NBR WELLENDICHTRING / OIL-SEAL
40/80/8 A NBR WELLENDICHTRING / OIL-SEAL*
40/80/8 AS NBR WELLENDICHTRING / OIL-SEAL
40/80/10 A NBR WELLENDICHTRING / OIL-SEAL*
40/80/10 AS NBR WELLENDICHTRING / OIL-SEAL*
40/80/12 AS NBR WELLENDICHTRING / OIL-SEAL
40/90/8 AS NBR WELLENDICHTRING / OIL-SEAL
40/90/10 A NBR WELLENDICHTRING / OIL-SEAL*
40/90/10 AS NBR WELLENDICHTRING / OIL-SEAL
42/50/7 AS NBR WELLENDICHTRING / OIL-SEAL
42/52/7 AS NBR WELLENDICHTRING / OIL-SEAL
42/52/8 AS NBR WELLENDICHTRING / OIL-SEAL*
42/55/7 A NBR WELLENDICHTRING / OIL-SEAL
42/55/7 AS NBR WELLENDICHTRING / OIL-SEAL
42/55/8 A NBR WELLENDICHTRING / OIL-SEAL*
42/55/8 AS NBR WELLENDICHTRING / OIL-SEAL*
42/55/10 AS NBR WELLENDICHTRING / OIL-SEAL
42/56/7 A NBR WELLENDICHTRING / OIL-SEAL*
42/56/7 AS NBR WELLENDICHTRING / OIL-SEAL*
42/58/10 A NBR WELLENDICHTRING / OIL-SEAL*
42/60/7 AS NBR WELLENDICHTRING / OIL-SEAL
42/60/10 AS NBR WELLENDICHTRING / OIL-SEAL
42/62/7 A NBR WELLENDICHTRING / OIL-SEAL*
42/62/7 AS NBR WELLENDICHTRING / OIL-SEAL*
42/62/7/7,5 AS-P NBR WELLENDICHTRING / OIL-SEAL
42/62/8 A NBR WELLENDICHTRING / OIL-SEAL*
42/62/8 AS NBR WELLENDICHTRING / OIL-SEAL
42/62/8 AS-P NBR WELLENDICHTRING / OIL-SEAL*
42/62/10 A NBR WELLENDICHTRING / OIL-SEAL*
42/62/10 AS NBR WELLENDICHTRING / OIL-SEAL*
42/65/10 A NBR WELLENDICHTRING / OIL-SEAL*
42/65/10 AS NBR WELLENDICHTRING / OIL-SEAL*
42/68/10 AS NBR WELLENDICHTRING / OIL-SEAL*
42/72/8 A NBR WELLENDICHTRING / OIL-SEAL*
42/72/8 AS NBR WELLENDICHTRING / OIL-SEAL*
42/72/10 A NBR WELLENDICHTRING / OIL-SEAL*
42/72/10 AS NBR WELLENDICHTRING / OIL-SEAL*

43/60/10 AS NBR WELLENDICHTRING / OIL-SEAL
44/60/10 AS NBR WELLENDICHTRING / OIL-SEAL
44/62/10 AS NBR WELLENDICHTRING / OIL-SEAL
44/65/10 AS NBR WELLENDICHTRING / OIL-SEAL
45/52/8 AS NBR WELLENDICHTRING / OIL-SEAL
45/55/7 A NBR WELLENDICHTRING / OIL-SEAL*
45/55/7 AS NBR WELLENDICHTRING / OIL-SEAL*
45/55/7 AS-P NBR WELLENDICHTRING / OIL-SEAL*
45/55/8 AS NBR WELLENDICHTRING / OIL-SEAL
45/58/6 AS-P NBR WELLENDICHTRING / OIL-SEAL
45/58/7 AS NBR WELLENDICHTRING / OIL-SEAL*
45/58/7 AS NBR SSS WELLENDICHTRING / OIL-SEAL
45/58/7 AS-P NBR WELLENDICHTRING / OIL-SEAL*
45/58/8 AS NBR WELLENDICHTRING / OIL-SEAL
45/58/10 AS NBR WELLENDICHTRING / OIL-SEAL
45/60/7 A NBR WELLENDICHTRING / OIL-SEAL*
45/60/7 AS NBR WELLENDICHTRING / OIL-SEAL*
45/60/7/7,5 AS-P NBR WELLENDICHTRING / OIL-SEAL
45/60/8 A NBR WELLENDICHTRING / OIL-SEAL*
45/60/8 AS NBR WELLENDICHTRING / OIL-SEAL*
45/60/10 AS NBR WELLENDICHTRING / OIL-SEAL*
45/60/10/13 AS NBR WELLENDICHTRING / OIL-SEAL
45/62/7 A NBR WELLENDICHTRING / OIL-SEAL*
45/62/7 AS NBR WELLENDICHTRING / OIL-SEAL*
45/62/7 AS-P NBR WELLENDICHTRING / OIL-SEAL*
45/62/8 A NBR WELLENDICHTRING / OIL-SEAL*
45/62/8 AS NBR WELLENDICHTRING / OIL-SEAL*
45/62/10 A NBR WELLENDICHTRING / OIL-SEAL*
45/62/10 AS NBR WELLENDICHTRING / OIL-SEAL*
45/62/12 AS NBR WELLENDICHTRING / OIL-SEAL
45/65/7 AS-P NBR WELLENDICHTRING / OIL-SEAL*
45/65/8 A NBR WELLENDICHTRING / OIL-SEAL*
45/65/8 AS NBR WELLENDICHTRING / OIL-SEAL*
45/65/8 AS-P NBR WELLENDICHTRING / OIL-SEAL*
45/65/10 A NBR WELLENDICHTRING / OIL-SEAL*
45/65/10 AS NBR WELLENDICHTRING / OIL-SEAL*
45/68/10 A NBR WELLENDICHTRING / OIL-SEAL*
45/68/10 AS NBR WELLENDICHTRING / OIL-SEAL*
45/68/12 A NBR WELLENDICHTRING / OIL-SEAL
45/70/10 AS NBR WELLENDICHTRING / OIL-SEAL*
45/72/7 A NBR WELLENDICHTRING / OIL-SEAL*
45/72/8 A NBR WELLENDICHTRING / OIL-SEAL*
45/72/8 AS NBR WELLENDICHTRING / OIL-SEAL*
45/72/10 A NBR WELLENDICHTRING / OIL-SEAL*
45/72/10 AS NBR WELLENDICHTRING / OIL-SEAL*
45/72/12 AS NBR WELLENDICHTRING / OIL-SEAL
45/75/8 A NBR WELLENDICHTRING / OIL-SEAL*
45/75/8 AS NBR WELLENDICHTRING / OIL-SEAL*
45/75/8/8,5 AS-P NBR WELLENDICHTRING / OIL-SEAL
45/75/10 AS NBR WELLENDICHTRING / OIL-SEAL*

45/80/8 AS NBR WELLENDICHTRING / OIL-SEAL
45/80/10 A NBR WELLENDICHTRING / OIL-SEAL*
45/80/10 AS NBR WELLENDICHTRING / OIL-SEAL*
45/80/13 A NBR WELLENDICHTRING / OIL-SEAL
45/85/7 AS NBR WELLENDICHTRING / OIL-SEAL
45/85/10 AS NBR WELLENDICHTRING / OIL-SEAL*
45/90/10 AS NBR WELLENDICHTRING / OIL-SEAL*
45/100/10 A NBR WELLENDICHTRING / OIL-SEAL
46,8/61,3/4 A NBR WELLENDICHTRING / OIL-SEAL
46/64/8 A NBR WELLENDICHTRING / OIL-SEAL
46/70/10 AS NBR WELLENDICHTRING / OIL-SEAL
47/58/6 A NBR WELLENDICHTRING / OIL-SEAL
47/62/7 AS-P NBR WELLENDICHTRING / OIL-SEAL*
47/62/8 AS NBR WELLENDICHTRING / OIL-SEAL
47/65/10 AS-P NBR WELLENDICHTRING / OIL-SEAL*
47/70/10 AS NBR WELLENDICHTRING / OIL-SEAL
48/62/8 A NBR WELLENDICHTRING / OIL-SEAL*
48/62/8 AS NBR WELLENDICHTRING / OIL-SEAL*
48/65/10 A NBR WELLENDICHTRING / OIL-SEAL*
48/65/10 AS NBR WELLENDICHTRING / OIL-SEAL*
48/68/8 AS NBR WELLENDICHTRING / OIL-SEAL
48/68/10 AS NBR WELLENDICHTRING / OIL-SEAL*
48/70/10 AS NBR WELLENDICHTRING / OIL-SEAL*
48/72/8 A NBR WELLENDICHTRING / OIL-SEAL*
48/72/8 AS NBR WELLENDICHTRING / OIL-SEAL*
48/72/10 A NBR WELLENDICHTRING / OIL-SEAL*
48/72/10 AS NBR WELLENDICHTRING / OIL-SEAL*
48/72/12 AS NBR WELLENDICHTRING / OIL-SEAL
48/80/10 A NBR WELLENDICHTRING / OIL-SEAL*
48/80/10 AS NBR WELLENDICHTRING / OIL-SEAL
49/65/10 A NBR WELLENDICHTRING / OIL-SEAL*
50/60/7 A NBR WELLENDICHTRING / OIL-SEAL*
50/60/10 AS NBR WELLENDICHTRING / OIL-SEAL
50/62/7 A NBR WELLENDICHTRING / OIL-SEAL*
50/62/7 AS NBR WELLENDICHTRING / OIL-SEAL*
50/62/8 AS NBR WELLENDICHTRING / OIL-SEAL*
50/62/10 A NBR WELLENDICHTRING / OIL-SEAL
50/62/10 AS NBR WELLENDICHTRING / OIL-SEAL
50/65/7 AS-P NBR WELLENDICHTRING / OIL-SEAL*
50/65/8 A NBR WELLENDICHTRING / OIL-SEAL*
50/65/8 A NBR SSS WELLENDICHTRING / OIL-SEAL
50/65/8 AS NBR WELLENDICHTRING / OIL-SEAL*
50/65/8 AS-P NBR WELLENDICHTRING / OIL-SEAL*
50/65/10 A NBR WELLENDICHTRING / OIL-SEAL*
50/65/10 AS NBR WELLENDICHTRING / OIL-SEAL*
50/68/7/7,5 AS-P NBR WELLENDICHTRING / OIL-SEAL
50/68/8 A NBR WELLENDICHTRING / OIL-SEAL*
50/68/8 AS NBR WELLENDICHTRING / OIL-SEAL*
50/68/8 AS-P NBR WELLENDICHTRING / OIL-SEAL*
50/68/10 A NBR WELLENDICHTRING / OIL-SEAL*

50/68/10 AS NBR WELLENDICHTRING / OIL-SEAL*
50/70/8 A NBR WELLENDICHTRING / OIL-SEAL*
50/70/8 AS NBR WELLENDICHTRING / OIL-SEAL
50/70/10 A NBR WELLENDICHTRING / OIL-SEAL*
50/70/10 AS NBR WELLENDICHTRING / OIL-SEAL*
50/70/12 A NBR WELLENDICHTRING / OIL-SEAL
50/70/12 AS NBR WELLENDICHTRING / OIL-SEAL
50/72/7 AS-P NBR WELLENDICHTRING / OIL-SEAL*
50/72/8 A NBR WELLENDICHTRING / OIL-SEAL*
50/72/8 AS NBR WELLENDICHTRING / OIL-SEAL*
50/72/8/10 AS-P NBR WELLENDICHTRING / OIL-SEAL
50/72/10 A NBR WELLENDICHTRING / OIL-SEAL*
50/72/10 A NBR SSS WELLENDICHTRING / OIL-SEAL
50/72/10 AS NBR WELLENDICHTRING / OIL-SEAL*
50/72/12 AS NBR WELLENDICHTRING / OIL-SEAL*
50/75/10 A NBR WELLENDICHTRING / OIL-SEAL*
50/75/10 AS NBR WELLENDICHTRING / OIL-SEAL*
50/75/12 A NBR WELLENDICHTRING / OIL-SEAL
50/75/12 AS NBR WELLENDICHTRING / OIL-SEAL
50/80/8 A NBR WELLENDICHTRING / OIL-SEAL*
50/80/8 AS NBR WELLENDICHTRING / OIL-SEAL*
50/80/10 A NBR WELLENDICHTRING / OIL-SEAL*
50/80/10 AS NBR WELLENDICHTRING / OIL-SEAL*
50/80/13 AS NBR WELLENDICHTRING / OIL-SEAL
50/85/8 AS NBR WELLENDICHTRING / OIL-SEAL
50/85/10 AS NBR WELLENDICHTRING / OIL-SEAL
50/90/8 AS NBR WELLENDICHTRING / OIL-SEAL
50/90/10 AS NBR WELLENDICHTRING / OIL-SEAL*
50/100/10 AS NBR WELLENDICHTRING / OIL-SEAL
50/110/10,5 A NBR WELLENDICHTRING / OIL-SEAL
50/110/12 AS NBR WELLENDICHTRING / OIL-SEAL
52/62/8 A NBR WELLENDICHTRING / OIL-SEAL*
52/65/8 AS NBR WELLENDICHTRING / OIL-SEAL
52/68/7 AS NBR WELLENDICHTRING / OIL-SEAL
52/68/8 A NBR WELLENDICHTRING / OIL-SEAL*
52/68/8 AS NBR WELLENDICHTRING / OIL-SEAL*
52/68/10 AS NBR WELLENDICHTRING / OIL-SEAL
52/70/8 AS NBR WELLENDICHTRING / OIL-SEAL
52/72/7/7,5 AS-P NBR WELLENDICHTRING / OIL-SEAL
52/72/8 A NBR WELLENDICHTRING / OIL-SEAL*
52/72/8 AS NBR WELLENDICHTRING / OIL-SEAL*
52/72/10 AS NBR WELLENDICHTRING / OIL-SEAL*
52/75/10 AS NBR WELLENDICHTRING / OIL-SEAL
52/75/12 AS NBR WELLENDICHTRING / OIL-SEAL
52/80/10 AS NBR WELLENDICHTRING / OIL-SEAL
52/85/10 A NBR WELLENDICHTRING / OIL-SEAL*
52/85/10 AS NBR WELLENDICHTRING / OIL-SEAL*
52/100/10 AS NBR WELLENDICHTRING / OIL-SEAL
54/72/10 AS NBR WELLENDICHTRING / OIL-SEAL
54/90/13 A NBR WELLENDICHTRING / OIL-SEAL

55/65/10 AS NBR WELLENDICHTRING / OIL-SEAL
55/68/7 AS-P NBR WELLENDICHTRING / OIL-SEAL*
55/68/8 A NBR WELLENDICHTRING / OIL-SEAL*
55/70/7/7,5 AS-P NBR WELLENDICHTRING / OIL-SEAL
55/70/8 A NBR WELLENDICHTRING / OIL-SEAL*
55/70/8 AS NBR WELLENDICHTRING / OIL-SEAL*
55/70/8 AS-P NBR WELLENDICHTRING / OIL-SEAL*
55/70/10 A NBR WELLENDICHTRING / OIL-SEAL*
55/70/10 AS NBR WELLENDICHTRING / OIL-SEAL*
55/70/12 AS NBR WELLENDICHTRING / OIL-SEAL
55/72/7 AS-P NBR WELLENDICHTRING / OIL-SEAL*
55/72/8 A NBR WELLENDICHTRING / OIL-SEAL*
55/72/8 AS NBR WELLENDICHTRING / OIL-SEAL*
55/72/8/8,5 AS-P NBR WELLENDICHTRING / OIL-SEAL
55/72/10 A NBR WELLENDICHTRING / OIL-SEAL*
55/72/10 AS NBR WELLENDICHTRING / OIL-SEAL*
55/72/12 AS NBR WELLENDICHTRING / OIL-SEAL
55/75/7 AS-P NBR WELLENDICHTRING / OIL-SEAL
55/75/8 AS NBR WELLENDICHTRING / OIL-SEAL*
55/75/10 A NBR WELLENDICHTRING / OIL-SEAL*
55/75/10 AS NBR WELLENDICHTRING / OIL-SEAL*
55/75/12 A NBR WELLENDICHTRING / OIL-SEAL*
55/78/10 AS NBR WELLENDICHTRING / OIL-SEAL
55/78/12 AS NBR WELLENDICHTRING / OIL-SEAL
55/80/8 A NBR WELLENDICHTRING / OIL-SEAL*
55/80/8 AS NBR WELLENDICHTRING / OIL-SEAL*
55/80/10 A NBR WELLENDICHTRING / OIL-SEAL*
55/80/10 AS NBR WELLENDICHTRING / OIL-SEAL*
55/82/10 AS NBR WELLENDICHTRING / OIL-SEAL
55/85/8 A NBR WELLENDICHTRING / OIL-SEAL*
55/85/8 AS NBR WELLENDICHTRING / OIL-SEAL
55/85/10 AS NBR WELLENDICHTRING / OIL-SEAL*
55/90/8 A NBR WELLENDICHTRING / OIL-SEAL*
55/90/8 AS NBR WELLENDICHTRING / OIL-SEAL*
55/90/10 A NBR WELLENDICHTRING / OIL-SEAL*
55/90/10 AS NBR WELLENDICHTRING / OIL-SEAL*
55/100/10 AS NBR WELLENDICHTRING / OIL-SEAL*
55/100/12 A NBR WELLENDICHTRING / OIL-SEAL*
55/100/13 AS NBR WELLENDICHTRING / OIL-SEAL
56/70/8 A NBR WELLENDICHTRING / OIL-SEAL*
56/72/8 A NBR WELLENDICHTRING / OIL-SEAL*
56/72/8 AS-P NBR WELLENDICHTRING / OIL-SEAL*
56/80/8 A NBR WELLENDICHTRING / OIL-SEAL*
56/80/8 AS NBR WELLENDICHTRING / OIL-SEAL
56/85/8 A NBR WELLENDICHTRING / OIL-SEAL*
57/72/9 AS NBR WELLENDICHTRING / OIL-SEAL
57,15/76,2/12,7 AS NBR WELLENDICHTRING / OIL-SEAL
58/72/8 A NBR WELLENDICHTRING / OIL-SEAL*
58/72/8 AS NBR WELLENDICHTRING / OIL-SEAL*
58/75/8 AS NBR WELLENDICHTRING / OIL-SEAL

58/75/10 AS NBR WELLENDICHTRING / OIL-SEAL
58/78/13 A NBR WELLENDICHTRING / OIL-SEAL
58/80/8 A NBR WELLENDICHTRING / OIL-SEAL*
58/80/8 AS NBR WELLENDICHTRING / OIL-SEAL
58/80/9 AS NBR WELLENDICHTRING / OIL-SEAL
58/80/10 AS-P NBR WELLENDICHTRING / OIL-SEAL*
58/90/10 A NBR WELLENDICHTRING / OIL-SEAL*
60/70/7 A NBR WELLENDICHTRING / OIL-SEAL*
60/70/7 AS NBR WELLENDICHTRING / OIL-SEAL
60/72/8 AS NBR WELLENDICHTRING / OIL-SEAL*
60/72/10 AS NBR WELLENDICHTRING / OIL-SEAL
60/75/8 A NBR WELLENDICHTRING / OIL-SEAL*
60/75/8 AS NBR WELLENDICHTRING / OIL-SEAL*
60/75/8 AS-P NBR WELLENDICHTRING / OIL-SEAL*
60/75/10 AS NBR WELLENDICHTRING / OIL-SEAL*
60/78/10 AS NBR WELLENDICHTRING / OIL-SEAL
60/80/7 AS NBR WELLENDICHTRING / OIL-SEAL*
60/80/7/7,5 AS-P NBR WELLENDICHTRING / OIL-SEAL*
60/80/8 A NBR WELLENDICHTRING / OIL-SEAL*
60/80/8 AS NBR WELLENDICHTRING / OIL-SEAL*
60/80/10 A NBR WELLENDICHTRING / OIL-SEAL*
60/80/10 AS NBR WELLENDICHTRING / OIL-SEAL*
60/80/12 A NBR WELLENDICHTRING / OIL-SEAL
60/80/12 AS NBR WELLENDICHTRING / OIL-SEAL
60/82/12 AS NBR WELLENDICHTRING / OIL-SEAL
60/85/8 A NBR WELLENDICHTRING / OIL-SEAL*
60/85/8 AS NBR WELLENDICHTRING / OIL-SEAL*
60/85/10 A NBR WELLENDICHTRING / OIL-SEAL*
60/85/10 AS NBR WELLENDICHTRING / OIL-SEAL*
60/85/13 A NBR WELLENDICHTRING / OIL-SEAL
60/85/13 AS NBR WELLENDICHTRING / OIL-SEAL
60/90/7 AS-P NBR WELLENDICHTRING / OIL-SEAL*
60/90/8 A NBR WELLENDICHTRING / OIL-SEAL*
60/90/8 AS NBR WELLENDICHTRING / OIL-SEAL*
60/90/8,5 AS3X7-O-TE NBR WELLENDICHTRING / OIL-SEAL,
60/90/10 A NBR WELLENDICHTRING / OIL-SEAL*
60/90/10 AS NBR WELLENDICHTRING / OIL-SEAL*
60/90/13 AS NBR WELLENDICHTRING / OIL-SEAL
60/95/10 A NBR WELLENDICHTRING / OIL-SEAL*
60/95/10 AS NBR WELLENDICHTRING / OIL-SEAL*
60/100/10 A NBR WELLENDICHTRING / OIL-SEAL
60/100/10 AS NBR WELLENDICHTRING / OIL-SEAL
60/110/8 AS NBR WELLENDICHTRING / OIL-SEAL*
60/110/12 AS NBR WELLENDICHTRING / OIL-SEAL*
60/110/13 A NBR WELLENDICHTRING / OIL-SEAL*
62/80/10 AS NBR WELLENDICHTRING / OIL-SEAL
62/85/7 AS-P NBR WELLENDICHTRING / OIL-SEAL*
62/85/10 A NBR WELLENDICHTRING / OIL-SEAL*
62/85/10 AS NBR WELLENDICHTRING / OIL-SEAL*
62/85/12 AS NBR WELLENDICHTRING / OIL-SEAL

62/90/10 A NBR WELLENDICHTRING / OIL-SEAL*
62/90/10 AS NBR WELLENDICHTRING / OIL-SEAL*
62/100/12 A NBR WELLENDICHTRING / OIL-SEAL*
63/80/9 AS NBR WELLENDICHTRING / OIL-SEAL*
63/85/10 A NBR WELLENDICHTRING / OIL-SEAL*
63/90/10 A NBR WELLENDICHTRING / OIL-SEAL*
63/90/10 AS NBR WELLENDICHTRING / OIL-SEAL
64/80/8 A NBR WELLENDICHTRING / OIL-SEAL*
65/75/8 AS NBR WELLENDICHTRING / OIL-SEAL*
65/80/7/7,5 AS-P NBR WELLENDICHTRING / OIL-SEAL
65/80/8 A NBR WELLENDICHTRING / OIL-SEAL*
65/80/8 AS NBR WELLENDICHTRING / OIL-SEAL*
65/80/10 AS NBR WELLENDICHTRING / OIL-SEAL*
65/85/8 A NBR WELLENDICHTRING / OIL-SEAL*
65/85/8 AS-P NBR WELLENDICHTRING / OIL-SEAL*
65/85/10 A NBR WELLENDICHTRING / OIL-SEAL*
65/85/10 AS NBR WELLENDICHTRING / OIL-SEAL*
65/85/12 AS NBR WELLENDICHTRING / OIL-SEAL*
65/85/13 A NBR WELLENDICHTRING / OIL-SEAL
65/85/13 AS NBR WELLENDICHTRING / OIL-SEAL
65/90/10 A NBR WELLENDICHTRING / OIL-SEAL*
65/90/10 AS NBR WELLENDICHTRING / OIL-SEAL*
65/90/10 AS-P NBR WELLENDICHTRING / OIL-SEAL*
65/90/12 A NBR WELLENDICHTRING / OIL-SEAL
65/90/12 AS NBR WELLENDICHTRING / OIL-SEAL
65/90/13 AS NBR WELLENDICHTRING / OIL-SEAL
65/95/10 A NBR WELLENDICHTRING / OIL-SEAL*
65/95/10 AS NBR WELLENDICHTRING / OIL-SEAL*
65/95/12 AS NBR WELLENDICHTRING / OIL-SEAL
65/100/10 A NBR WELLENDICHTRING / OIL-SEAL*
65/100/10 AS NBR WELLENDICHTRING / OIL-SEAL*
65/100/13 AS NBR WELLENDICHTRING / OIL-SEAL
65/110/10 AS NBR WELLENDICHTRING / OIL-SEAL
65/120/10 AS NBR WELLENDICHTRING / OIL-SEAL
65/120/12 AS NBR WELLENDICHTRING / OIL-SEAL
68/85/8 A NBR WELLENDICHTRING / OIL-SEAL
68/85/8 AS NBR WELLENDICHTRING / OIL-SEAL
68/85/10 AS NBR WELLENDICHTRING / OIL-SEAL
68/90/7 AS NBR WELLENDICHTRING / OIL-SEAL
68/90/10 A NBR WELLENDICHTRING / OIL-SEAL*
68/90/10 AS NBR WELLENDICHTRING / OIL-SEAL*
68/90/10 AS-P NBR WELLENDICHTRING / OIL-SEAL*
68/100/10 A NBR WELLENDICHTRING / OIL-SEAL*
68/100/13 AS NBR WELLENDICHTRING / OIL-SEAL
70/85/8 A NBR WELLENDICHTRING / OIL-SEAL*
70/85/8 AS NBR WELLENDICHTRING / OIL-SEAL*
70/85/10 A NBR WELLENDICHTRING / OIL-SEAL*
70/85/10/10,5 AS-P NBR WELLENDICHTRING / OIL-SEAL
70/90/7 AS-P NBR WELLENDICHTRING / OIL-SEAL*
70/90/10 A NBR WELLENDICHTRING / OIL-SEAL*

70/90/10 AS NBR WELLENDICHTRING / OIL-SEAL*
70/90/10 AS-P NBR WELLENDICHTRING / OIL-SEAL*
70/90/12 AS NBR WELLENDICHTRING / OIL-SEAL
70/90/13 AS NBR WELLENDICHTRING / OIL-SEAL
70/92/12 AS NBR WELLENDICHTRING / OIL-SEAL
70/95/10 A NBR WELLENDICHTRING / OIL-SEAL*
70/95/10 AS NBR WELLENDICHTRING / OIL-SEAL*
70/95/12 AS NBR WELLENDICHTRING / OIL-SEAL*
70/95/13 A NBR WELLENDICHTRING / OIL-SEAL*
70/100/10 A NBR WELLENDICHTRING / OIL-SEAL*
70/100/10 AS-P NBR WELLENDICHTRING / OIL-SEAL*
70/100/13 AS NBR WELLENDICHTRING / OIL-SEAL*
70/110/8 A NBR WELLENDICHTRING / OIL-SEAL
70/110/10 AS NBR WELLENDICHTRING / OIL-SEAL*
70/110/12 A NBR WELLENDICHTRING / OIL-SEAL*
70/110/12 AS NBR WELLENDICHTRING / OIL-SEAL*
70/110/13 AS NBR WELLENDICHTRING / OIL-SEAL
70/120/10 AS NBR WELLENDICHTRING / OIL-SEAL
72/90/10 A NBR WELLENDICHTRING / OIL-SEAL*
72/90/10 AS NBR WELLENDICHTRING / OIL-SEAL
72/95/10 A NBR WELLENDICHTRING / OIL-SEAL*
72/95/10 AS NBR WELLENDICHTRING / OIL-SEAL
72/95/12 A NBR WELLENDICHTRING / OIL-SEAL
72/100/10 A NBR WELLENDICHTRING / OIL-SEAL*
72/100/10 AS NBR WELLENDICHTRING / OIL-SEAL*
72/105/13 AS NBR WELLENDICHTRING / OIL-SEAL
72/110/12 A NBR WELLENDICHTRING / OIL-SEAL
73,5/110/13 AS NBR WELLENDICHTRING / OIL-SEAL
75/90/8 A NBR WELLENDICHTRING / OIL-SEAL*
75/90/8 AS NBR WELLENDICHTRING / OIL-SEAL*
75/90/10 A NBR WELLENDICHTRING / OIL-SEAL*
75/90/10 AS-P NBR WELLENDICHTRING / OIL-SEAL*
75/95/7/7,5 AS-P NBR WELLENDICHTRING / OIL-SEAL
75/95/9 AS NBR WELLENDICHTRING / OIL-SEAL*
75/95/10 A NBR WELLENDICHTRING / OIL-SEAL*
75/95/10 AS NBR WELLENDICHTRING / OIL-SEAL*
75/95/10 AS-P NBR WELLENDICHTRING / OIL-SEAL*
75/95/12 A NBR WELLENDICHTRING / OIL-SEAL*
75/100/8/8,5 AS-P NBR WELLENDICHTRING / OIL-SEAL
75/100/10 A NBR WELLENDICHTRING / OIL-SEAL*
75/100/10 AS NBR WELLENDICHTRING / OIL-SEAL*
75/100/12 A NBR WELLENDICHTRING / OIL-SEAL
75/100/12 AS NBR WELLENDICHTRING / OIL-SEAL*
75/100/13 A NBR WELLENDICHTRING / OIL-SEAL
75/100/13 AS NBR WELLENDICHTRING / OIL-SEAL
75/110/10 AS NBR WELLENDICHTRING / OIL-SEAL
75/110/12 A NBR WELLENDICHTRING / OIL-SEAL*
75/110/12 AS NBR WELLENDICHTRING / OIL-SEAL*
75/115/13 A NBR WELLENDICHTRING / OIL-SEAL
75/120/12 A NBR WELLENDICHTRING / OIL-SEAL*

75/120/12 AS NBR WELLENDICHTRING / OIL-SEAL
75/130/13 A NBR WELLENDICHTRING / OIL-SEAL
78/100/10 A NBR WELLENDICHTRING / OIL-SEAL*
78/100/13 AS NBR WELLENDICHTRING / OIL-SEAL
78/110/10 AS NBR WELLENDICHTRING / OIL-SEAL
78/110/12 A NBR WELLENDICHTRING / OIL-SEAL*
80/95/8 AS NBR WELLENDICHTRING / OIL-SEAL
80/95/10 AS NBR WELLENDICHTRING / OIL-SEAL
80/100/7/7,5 AS-P NBR WELLENDICHTRING / OIL-SEAL*
80/100/10 A NBR WELLENDICHTRING / OIL-SEAL*
80/100/10 AS NBR WELLENDICHTRING / OIL-SEAL*
80/100/12 A NBR WELLENDICHTRING / OIL-SEAL
80/100/12 AS NBR WELLENDICHTRING / OIL-SEAL
80/105/10 A NBR WELLENDICHTRING / OIL-SEAL*
80/105/12 A NBR WELLENDICHTRING / OIL-SEAL*
80/105/12 AS NBR WELLENDICHTRING / OIL-SEAL
80/105/13 A NBR WELLENDICHTRING / OIL-SEAL*
80/110/10 A NBR WELLENDICHTRING / OIL-SEAL*
80/110/10 AS NBR WELLENDICHTRING / OIL-SEAL*
80/110/12 A NBR WELLENDICHTRING / OIL-SEAL*
80/110/12 AS NBR WELLENDICHTRING / OIL-SEAL*
80/110/13 A NBR WELLENDICHTRING / OIL-SEAL
80/115/10 A NBR WELLENDICHTRING / OIL-SEAL
80/115/12 AS NBR WELLENDICHTRING / OIL-SEAL
80/120/10 AS NBR WELLENDICHTRING / OIL-SEAL
80/120/13 A NBR WELLENDICHTRING / OIL-SEAL*
80/125/10 AS NBR WELLENDICHTRING / OIL-SEAL*
82/105/10/12 AS NBR WELLENDICHTRING / OIL-SEAL
82/105/12 A NBR WELLENDICHTRING / OIL-SEAL*
82/110/12 AS NBR WELLENDICHTRING / OIL-SEAL
85/100/9 A NBR WELLENDICHTRING / OIL-SEAL*
85/100/10 AS NBR WELLENDICHTRING / OIL-SEAL
85/100/12 AS NBR WELLENDICHTRING / OIL-SEAL
85/105/8 A NBR WELLENDICHTRING / OIL-SEAL
85/105/10 A NBR WELLENDICHTRING / OIL-SEAL
85/105/10 AS NBR WELLENDICHTRING / OIL-SEAL*
85/105/12 AS-P NBR WELLENDICHTRING / OIL-SEAL*
85/105/13 A NBR WELLENDICHTRING / OIL-SEAL*
85/110/10 AS NBR WELLENDICHTRING / OIL-SEAL*
85/110/12 A NBR WELLENDICHTRING / OIL-SEAL*
85/110/12 AS NBR WELLENDICHTRING / OIL-SEAL*
85/110/12 A NBR WELLENDICHTRING / OIL-SEAL
85/110/13 A NBR WELLENDICHTRING / OIL-SEAL*
85/110/13 A-DUO NBR WELLENDICHTRING / OIL-SEAL
85/110/13 AS NBR WELLENDICHTRING / OIL-SEAL*
85/115/13 A NBR WELLENDICHTRING / OIL-SEAL
85/115/13 AS NBR WELLENDICHTRING / OIL-SEAL
85/120/7,5/8,5 AS-P NBR WELLENDICHTRING / OIL-SEAL
85/120/10 AS NBR WELLENDICHTRING / OIL-SEAL
85/120/12 A NBR WELLENDICHTRING / OIL-SEAL*

85/120/12 AS NBR WELLENDICHTRING / OIL-SEAL*
85/120/13 AS NBR WELLENDICHTRING / OIL-SEAL
85/125/13 AS NBR WELLENDICHTRING / OIL-SEAL
85/130/12 A NBR WELLENDICHTRING / OIL-SEAL*
85/130/12 AS NBR WELLENDICHTRING / OIL-SEAL*
85/140/12 AS NBR WELLENDICHTRING / OIL-SEAL*
85/150/12 AS NBR WELLENDICHTRING / OIL-SEAL
88/110/12 A NBR WELLENDICHTRING / OIL-SEAL*
88/110/12 AS NBR WELLENDICHTRING / OIL-SEAL
90/110/7,5 AS-P NBR WELLENDICHTRING / OIL-SEAL*
90/110/8 AS NBR WELLENDICHTRING / OIL-SEAL
90/110/10 A NBR WELLENDICHTRING / OIL-SEAL
90/110/10 AS NBR WELLENDICHTRING / OIL-SEAL*
90/110/12 A NBR WELLENDICHTRING / OIL-SEAL*
90/110/12 AS NBR WELLENDICHTRING / OIL-SEAL*
90/110/12 AS-P NBR WELLENDICHTRING / OIL-SEAL*
90/110/13 A NBR WELLENDICHTRING / OIL-SEAL*
90/110/13 AS NBR WELLENDICHTRING / OIL-SEAL
90/115/9 A NBR WELLENDICHTRING / OIL-SEAL*
90/115/12 AS NBR WELLENDICHTRING / OIL-SEAL*
90/115/13 AS NBR WELLENDICHTRING / OIL-SEAL*
90/120/10 AS NBR WELLENDICHTRING / OIL-SEAL*
90/120/12 A NBR WELLENDICHTRING / OIL-SEAL*
90/120/12 AS NBR WELLENDICHTRING / OIL-SEAL*
90/120/13 A NBR WELLENDICHTRING / OIL-SEAL*
90/120/13 AS NBR WELLENDICHTRING / OIL-SEAL*
90/125/12 AS-P NBR WELLENDICHTRING / OIL-SEAL*
90/125/13 AS NBR WELLENDICHTRING / OIL-SEAL
90/130/12 A NBR WELLENDICHTRING / OIL-SEAL*
90/130/12 AS NBR WELLENDICHTRING / OIL-SEAL*
90/130/13 AS NBR WELLENDICHTRING / OIL-SEAL
90/160/12 A NBR WELLENDICHTRING / OIL-SEAL
92/120/12 AS NBR WELLENDICHTRING / OIL-SEAL
92/120/13 A NBR WELLENDICHTRING / OIL-SEAL*
92/120/13 AS NBR WELLENDICHTRING / OIL-SEAL
95/110/7 AS NBR WELLENDICHTRING / OIL-SEAL
95/110/10 A NBR WELLENDICHTRING / OIL-SEAL*
95/110/10 AS NBR WELLENDICHTRING / OIL-SEAL
95/115/10 AS NBR WELLENDICHTRING / OIL-SEAL
95/115/13 A NBR WELLENDICHTRING / OIL-SEAL
95/115/13 AS NBR WELLENDICHTRING / OIL-SEAL
95/120/12 A NBR WELLENDICHTRING / OIL-SEAL*
95/120/12 AS NBR WELLENDICHTRING / OIL-SEAL*
95/120/13 A NBR WELLENDICHTRING / OIL-SEAL
95/120/13 AS NBR WELLENDICHTRING / OIL-SEAL
95/120/13/14 AS-P NBR WELLENDICHTRING / OIL-SEAL
95/120/12 AS-P NBR WELLENDICHTRING / OIL-SEAL
95/125/10 AS NBR WELLENDICHTRING / OIL-SEAL
95/125/12 A NBR WELLENDICHTRING / OIL-SEAL*
95/125/12 AS NBR WELLENDICHTRING / OIL-SEAL*

95/125/13 A NBR WELLENDICHTRING / OIL-SEAL
95/130/12 AS NBR WELLENDICHTRING / OIL-SEAL*
95/130/13 AS NBR WELLENDICHTRING / OIL-SEAL*
100/115/9 AS NBR WELLENDICHTRING / OIL-SEAL
100/120/7,5/8,5 AS-P NBR WELLENDICHTRING / OIL-SEAL
100/120/10 AS NBR WELLENDICHTRING / OIL-SEAL*
100/120/12 A NBR WELLENDICHTRING / OIL-SEAL*
100/120/12 A NBR SSS WELLENDICHTRING / OIL-SEAL
100/120/12 AS NBR WELLENDICHTRING / OIL-SEAL*
100/120/12 AS-P NBR WELLENDICHTRING / OIL-SEAL*
100/120/13 AS NBR WELLENDICHTRING / OIL-SEAL
100/125/10 AS NBR WELLENDICHTRING / OIL-SEAL*
100/125/12 A NBR WELLENDICHTRING / OIL-SEAL*
100/125/12 AS NBR WELLENDICHTRING / OIL-SEAL
100/125/13 AS NBR WELLENDICHTRING / OIL-SEAL*
100/130/12 A NBR WELLENDICHTRING / OIL-SEAL*
100/130/12 A NBR WELLENDICHTRING / OIL-SEAL
100/130/12 AS NBR WELLENDICHTRING / OIL-SEAL*
100/130/12/13 AS-P NBR WELLENDICHTRING / OIL-SEAL
100/130/13 A NBR WELLENDICHTRING / OIL-SEAL
100/130/13 AS NBR WELLENDICHTRING / OIL-SEAL*
100/130/13 AS NBR WELLENDICHTRING / OIL-SEAL
100/130/14 A NBR WELLENDICHTRING / OIL-SEAL*
100/140/12 AS NBR WELLENDICHTRING / OIL-SEAL
100/140/13 AS NBR WELLENDICHTRING / OIL-SEAL
100/150/13 AS NBR WELLENDICHTRING / OIL-SEAL*
105/125/12 A NBR WELLENDICHTRING / OIL-SEAL
105/125/13 A NBR WELLENDICHTRING / OIL-SEAL*
105/125/13 AS NBR WELLENDICHTRING / OIL-SEAL*
105/130/7,5 AS-P NBR WELLENDICHTRING / OIL-SEAL*
105/130/12 AS NBR WELLENDICHTRING / OIL-SEAL*
105/130/13 A NBR WELLENDICHTRING / OIL-SEAL
105/130/13 AS NBR WELLENDICHTRING / OIL-SEAL
105/130/15 A NBR WELLENDICHTRING / OIL-SEAL
105/140/12 A NBR WELLENDICHTRING / OIL-SEAL*
105/140/12 AS-P NBR WELLENDICHTRING / OIL-SEAL*
105/140/13 A NBR WELLENDICHTRING / OIL-SEAL
105/140/13 AS NBR WELLENDICHTRING / OIL-SEAL
105/150/15 AS NBR WELLENDICHTRING / OIL-SEAL
105/160/12 AS NBR WELLENDICHTRING / OIL-SEAL*
110/130/8 A NBR WELLENDICHTRING / OIL-SEAL*
110/130/10 AS NBR WELLENDICHTRING / OIL-SEAL
110/130/12 A NBR WELLENDICHTRING / OIL-SEAL*
110/130/12 AS NBR WELLENDICHTRING / OIL-SEAL*
110/130/12 AS-P NBR WELLENDICHTRING / OIL-SEAL*
110/130/13 A NBR WELLENDICHTRING / OIL-SEAL*
110/130/13 AS NBR WELLENDICHTRING / OIL-SEAL*
110/135/12 A NBR WELLENDICHTRING / OIL-SEAL*
110/140/10 A NBR WELLENDICHTRING / OIL-SEAL*
110/140/12 A NBR WELLENDICHTRING / OIL-SEAL*

110/140/12 AS NBR WELLENDICHTRING / OIL-SEAL*
110/140/13 A NBR WELLENDICHTRING / OIL-SEAL*
110/140/13 AS NBR WELLENDICHTRING / OIL-SEAL*
110/140/14 AS NBR WELLENDICHTRING / OIL-SEAL
110/145/15 AS NBR WELLENDICHTRING / OIL-SEAL
110/150/8 AS-P NBR WELLENDICHTRING / OIL-SEAL
110/150/15 A NBR WELLENDICHTRING / OIL-SEAL
112/140/13 AS NBR WELLENDICHTRING / OIL-SEAL
115/135/12 AS NBR WELLENDICHTRING / OIL-SEAL
115/140/10 A NBR WELLENDICHTRING / OIL-SEAL*
115/140/12 A NBR WELLENDICHTRING / OIL-SEAL*
115/140/12 A NBR SSS WELLENDICHTRING / OIL-SEAL
115/140/12 AS NBR WELLENDICHTRING / OIL-SEAL*
115/140/13 AS NBR WELLENDICHTRING / OIL-SEAL
115/145/12 A NBR WELLENDICHTRING / OIL-SEAL
115/145/13 AS NBR WELLENDICHTRING / OIL-SEAL
115/145/14 AS NBR WELLENDICHTRING / OIL-SEAL
115/150/12 A NBR WELLENDICHTRING / OIL-SEAL*
115/150/12 AS NBR WELLENDICHTRING / OIL-SEAL
115/165/15 AS NBR WELLENDICHTRING / OIL-SEAL
120/140/12 AS NBR WELLENDICHTRING / OIL-SEAL
120/140/13 A NBR WELLENDICHTRING / OIL-SEAL*
120/140/13 AS NBR WELLENDICHTRING / OIL-SEAL
120/140/13 AS-P NBR WELLENDICHTRING / OIL-SEAL*
120/140/7,5/8,5 AS-P NBR WELLENDICHTRING / OIL-SEAL
120/145/12 AS NBR WELLENDICHTRING / OIL-SEAL
120/145/15 AS NBR WELLENDICHTRING / OIL-SEAL
120/150/12 A NBR WELLENDICHTRING / OIL-SEAL*
120/150/12 A NBR WELLENDICHTRING / OIL-SEAL
120/150/12 AS NBR WELLENDICHTRING / OIL-SEAL*
120/150/12 AS-P NBR WELLENDICHTRING / OIL-SEAL*
120/150/13 A NBR WELLENDICHTRING / OIL-SEAL*
120/150/13 AS NBR WELLENDICHTRING / OIL-SEAL
120/150/15 A NBR WELLENDICHTRING / OIL-SEAL
120/150/15 AS NBR WELLENDICHTRING / OIL-SEAL*
120/150/15/15,5 AS-P NBR WELLENDICHTRING / OIL-SEAL
120/160/12 A NBR WELLENDICHTRING / OIL-SEAL*
120/160/12 AS NBR WELLENDICHTRING / OIL-SEAL
120/160/15 A NBR WELLENDICHTRING / OIL-SEAL*
120/160/15 AS NBR WELLENDICHTRING / OIL-SEAL
120/180/15 A NBR WELLENDICHTRING / OIL-SEAL
125/140/10 A NBR WELLENDICHTRING / OIL-SEAL*
125/140/13 AS NBR WELLENDICHTRING / OIL-SEAL
125/145/12 AS NBR WELLENDICHTRING / OIL-SEAL
125/150/12 A NBR WELLENDICHTRING / OIL-SEAL*
125/150/12 AS NBR WELLENDICHTRING / OIL-SEAL*
125/150/13 A NBR WELLENDICHTRING / OIL-SEAL
125/150/15 AS NBR WELLENDICHTRING / OIL-SEAL
125/155/12 AS NBR WELLENDICHTRING / OIL-SEAL*
125/160/12 A NBR WELLENDICHTRING / OIL-SEAL*

125/160/12 AS NBR WELLENDICHTRING / OIL-SEAL*
125/160/15 A NBR WELLENDICHTRING / OIL-SEAL
125/160/15 AS NBR WELLENDICHTRING / OIL-SEAL*
127/152,4/12,7 A NBR WELLENDICHTRING / OIL-SEAL
128/146/13,5 AS NBR WELLENDICHTRING / OIL-SEAL
128/150/13 A NBR WELLENDICHTRING / OIL-SEAL*
130/150/10 A NBR WELLENDICHTRING / OIL-SEAL*
130/150/10 AS NBR WELLENDICHTRING / OIL-SEAL
130/150/12 AS NBR WELLENDICHTRING / OIL-SEAL*
130/150/15 AS NBR WELLENDICHTRING / OIL-SEAL
130/155/10 A NBR WELLENDICHTRING / OIL-SEAL
130/160/12 A NBR WELLENDICHTRING / OIL-SEAL*
130/160/12 AS NBR WELLENDICHTRING / OIL-SEAL*
130/160/12 AS-P NBR WELLENDICHTRING / OIL-SEAL*
130/160/13 A NBR WELLENDICHTRING / OIL-SEAL*
130/160/15 A NBR WELLENDICHTRING / OIL-SEAL*
130/160/15 AS NBR WELLENDICHTRING / OIL-SEAL*
130/170/12 A NBR WELLENDICHTRING / OIL-SEAL*
130/170/12 AS NBR WELLENDICHTRING / OIL-SEAL*
130/170/13 A NBR WELLENDICHTRING / OIL-SEAL
130/170/13 AS NBR WELLENDICHTRING / OIL-SEAL
130/170/15 AS NBR WELLENDICHTRING / OIL-SEAL
135/160/12 A NBR WELLENDICHTRING / OIL-SEAL*
135/160/13 A NBR WELLENDICHTRING / OIL-SEAL
135/160/15 AS NBR WELLENDICHTRING / OIL-SEAL*
135/165/12 A NBR WELLENDICHTRING / OIL-SEAL
135/165/13 AS NBR WELLENDICHTRING / OIL-SEAL
135/165/14 AS NBR WELLENDICHTRING / OIL-SEAL
135/165/15 AS NBR WELLENDICHTRING / OIL-SEAL
135/170/12 A NBR WELLENDICHTRING / OIL-SEAL*
135/170/15 AS NBR WELLENDICHTRING / OIL-SEAL
140/160/12 AS NBR WELLENDICHTRING / OIL-SEAL*
140/160/13 A NBR WELLENDICHTRING / OIL-SEAL
140/160/13 AS NBR WELLENDICHTRING / OIL-SEAL
140/165/10 AS NBR WELLENDICHTRING / OIL-SEAL
140/165/12 A NBR WELLENDICHTRING / OIL-SEAL*
140/165/13 AS NBR WELLENDICHTRING / OIL-SEAL
140/170/12 A NBR WELLENDICHTRING / OIL-SEAL*
140/170/12 A NBR SSS WELLENDICHTRING / OIL-SEAL
140/170/12 AS NBR WELLENDICHTRING / OIL-SEAL*
140/170/13 AS NBR WELLENDICHTRING / OIL-SEAL
140/170/14 AS NBR WELLENDICHTRING / OIL-SEAL
140/170/15 A NBR WELLENDICHTRING / OIL-SEAL*
140/170/15 A NBR WELLENDICHTRING / OIL-SEAL
140/170/15 AS NBR WELLENDICHTRING / OIL-SEAL*
140/170/15/16 AS-P NBR WELLENDICHTRING / OIL-SEAL
140/175/15 AS NBR WELLENDICHTRING / OIL-SEAL
140/180/12 A NBR WELLENDICHTRING / OIL-SEAL*
140/180/12 AS NBR WELLENDICHTRING / OIL-SEAL*
140/180/13 A NBR WELLENDICHTRING / OIL-SEAL

140/180/15 A NBR WELLENDICHTRING / OIL-SEAL*
140/210/15 AS NBR WELLENDICHTRING / OIL-SEAL
142/168/14 AS NBR WELLENDICHTRING / OIL-SEAL
145/170/12 AS NBR WELLENDICHTRING / OIL-SEAL
145/170/15 A NBR WELLENDICHTRING / OIL-SEAL*
145/170/15 AS NBR WELLENDICHTRING / OIL-SEAL*
145/175/15 A NBR WELLENDICHTRING / OIL-SEAL*
145/175/15 AS NBR WELLENDICHTRING / OIL-SEAL*
145/180/12 A NBR WELLENDICHTRING / OIL-SEAL*
145/180/13 A NBR WELLENDICHTRING / OIL-SEAL*
145/180/13 AS NBR WELLENDICHTRING / OIL-SEAL
145/180/14 A NBR WELLENDICHTRING / OIL-SEAL
145/180/15 AS NBR WELLENDICHTRING / OIL-SEAL
146/163/7 A NBR WELLENDICHTRING / OIL-SEAL
148/170/14,5 A NBR WELLENDICHTRING / OIL-SEAL*
148/170/15 AS NBR WELLENDICHTRING / OIL-SEAL
150/170/12 A NBR WELLENDICHTRING / OIL-SEAL*
150/170/12 AS NBR WELLENDICHTRING / OIL-SEAL
150/170/15 A NBR WELLENDICHTRING / OIL-SEAL
150/180/12 A NBR WELLENDICHTRING / OIL-SEAL*
150/180/12 AS NBR WELLENDICHTRING / OIL-SEAL
150/180/13 A NBR WELLENDICHTRING / OIL-SEAL*
150/180/13 AS NBR WELLENDICHTRING / OIL-SEAL*
150/180/15 AS NBR WELLENDICHTRING / OIL-SEAL*
155/175/12 A NBR WELLENDICHTRING / OIL-SEAL*
155/180/15 AS NBR WELLENDICHTRING / OIL-SEAL
155/200/15 AS NBR WELLENDICHTRING / OIL-SEAL
160/180/10 AS NBR WELLENDICHTRING / OIL-SEAL*
160/185/10 A NBR WELLENDICHTRING / OIL-SEAL*
160/185/10 AS NBR WELLENDICHTRING / OIL-SEAL
160/185/13 AS NBR WELLENDICHTRING / OIL-SEAL
160/185/8,5/9,5 AS-P NBR WELLENDICHTRING / OIL-SEAL
160/190/15 A NBR WELLENDICHTRING / OIL-SEAL*
160/190/15 A NBR WELLENDICHTRING / OIL-SEAL
160/190/15 AS NBR WELLENDICHTRING / OIL-SEAL*
160/200/12 A NBR WELLENDICHTRING / OIL-SEAL*
160/200/12 AS NBR WELLENDICHTRING / OIL-SEAL
160/200/15 AS NBR WELLENDICHTRING / OIL-SEAL
165/190/13 A NBR WELLENDICHTRING / OIL-SEAL*
165/190/15 AS NBR WELLENDICHTRING / OIL-SEAL
165/200/15 A NBR WELLENDICHTRING / OIL-SEAL*
170/190/13 AS NBR WELLENDICHTRING / OIL-SEAL
170/190/15 A NBR WELLENDICHTRING / OIL-SEAL*
170/200/12 A NBR WELLENDICHTRING / OIL-SEAL*
170/200/12 AS NBR WELLENDICHTRING / OIL-SEAL
170/200/13 A NBR WELLENDICHTRING / OIL-SEAL
170/200/15 A NBR WELLENDICHTRING / OIL-SEAL*
170/200/15 AS NBR WELLENDICHTRING / OIL-SEAL*
170/210/15 AS NBR WELLENDICHTRING / OIL-SEAL
175/200/15 A NBR WELLENDICHTRING / OIL-SEAL*

175/200/15 AS NBR WELLENDICHTRING / OIL-SEAL*
175/215/15 AS NBR WELLENDICHTRING / OIL-SEAL
180/200/13 A NBR WELLENDICHTRING / OIL-SEAL*
180/200/15 AS NBR WELLENDICHTRING / OIL-SEAL
180/210/13 A NBR WELLENDICHTRING / OIL-SEAL
180/210/15 A NBR WELLENDICHTRING / OIL-SEAL*
180/210/15 AS NBR WELLENDICHTRING / OIL-SEAL*
180/210/8,5/9,5 AS-P NBR WELLENDICHTRING / OIL-SEAL*
180/215/16 A NBR WELLENDICHTRING / OIL-SEAL*
180/215/16 AS NBR WELLENDICHTRING / OIL-SEAL
180/220/12 AS NBR WELLENDICHTRING / OIL-SEAL
180/220/15 A NBR WELLENDICHTRING / OIL-SEAL*
180/220/16 A NBR WELLENDICHTRING / OIL-SEAL
180/220/16 AS NBR WELLENDICHTRING / OIL-SEAL
185/210/13 A NBR WELLENDICHTRING / OIL-SEAL*
185/210/13 AS NBR WELLENDICHTRING / OIL-SEAL
185/210/15 AS NBR WELLENDICHTRING / OIL-SEAL
185/215/16 A NBR WELLENDICHTRING / OIL-SEAL*
185/220/15 A NBR WELLENDICHTRING / OIL-SEAL
190/215/15 AS NBR WELLENDICHTRING / OIL-SEAL*
190/215/16 AS NBR WELLENDICHTRING / OIL-SEAL*
190/220/12 AS NBR WELLENDICHTRING / OIL-SEAL
190/220/15 A NBR WELLENDICHTRING / OIL-SEAL*
190/225/15 AS NBR WELLENDICHTRING / OIL-SEAL
190/225/16 A NBR WELLENDICHTRING / OIL-SEAL*
190/225/16 AS NBR WELLENDICHTRING / OIL-SEAL*
190/230/16 AS NBR WELLENDICHTRING / OIL-SEAL*
192/210/10 A NBR WELLENDICHTRING / OIL-SEAL
195/215/15 AS NBR WELLENDICHTRING / OIL-SEAL
195/230/15 AS NBR WELLENDICHTRING / OIL-SEAL*
200/225/15 A NBR WELLENDICHTRING / OIL-SEAL*
200/230/13 A NBR WELLENDICHTRING / OIL-SEAL*
200/230/15 A NBR WELLENDICHTRING / OIL-SEAL*
200/230/16 AS NBR WELLENDICHTRING / OIL-SEAL
200/240/15 AS NBR WELLENDICHTRING / OIL-SEAL*
200/250/15 A NBR WELLENDICHTRING / OIL-SEAL*
200/250/15 AS NBR WELLENDICHTRING / OIL-SEAL
205/230/16 A NBR WELLENDICHTRING / OIL-SEAL*
210/240/15 A NBR WELLENDICHTRING / OIL-SEAL*
210/240/15 AS NBR WELLENDICHTRING / OIL-SEAL*
210/240/16 AS NBR WELLENDICHTRING / OIL-SEAL
210/250/15 A NBR WELLENDICHTRING / OIL-SEAL*
210/250/15 A NBR WELLENDICHTRING / OIL-SEAL*
210/250/15 AS NBR WELLENDICHTRING / OIL-SEAL
215/240/12 A NBR WELLENDICHTRING / OIL-SEAL
220/250/15 A NBR WELLENDICHTRING / OIL-SEAL*
220/250/15 A NBR WELLENDICHTRING / OIL-SEAL
220/250/15 AS NBR WELLENDICHTRING / OIL-SEAL*
220/250/16 A NBR WELLENDICHTRING / OIL-SEAL
220/255/16 A NBR WELLENDICHTRING / OIL-SEAL

220/260/16 A NBR WELLENDICHTRING / OIL-SEAL*
230/260/15 A NBR WELLENDICHTRING / OIL-SEAL*
230/260/15 AS NBR WELLENDICHTRING / OIL-SEAL*
230/280/15 A NBR WELLENDICHTRING / OIL-SEAL*
230/280/15 AS NBR WELLENDICHTRING / OIL-SEAL
235/265/15 A NBR WELLENDICHTRING / OIL-SEAL
240/270/15 A NBR WELLENDICHTRING / OIL-SEAL*
240/270/15 AS NBR WELLENDICHTRING / OIL-SEAL*
240/275/16 A NBR WELLENDICHTRING / OIL-SEAL*
240/280/15 A NBR WELLENDICHTRING / OIL-SEAL*
240/280/16 AS NBR WELLENDICHTRING / OIL-SEAL
250/280/15 A NBR WELLENDICHTRING / OIL-SEAL*
250/280/15 A-P NBR WELLENDICHTRING / OIL-SEAL
250/280/15/17 AS-P NBR WELLENDICHTRING / OIL-SEAL*
250/290/15 AS NBR WELLENDICHTRING / OIL-SEAL
260/290/15 A NBR WELLENDICHTRING / OIL-SEAL*
260/290/15 AS NBR WELLENDICHTRING / OIL-SEAL
260/290/16 A NBR WELLENDICHTRING / OIL-SEAL
260/300/20 A NBR WELLENDICHTRING / OIL-SEAL*
260/300/20 AS NBR WELLENDICHTRING / OIL-SEAL
265/290/16 A NBR WELLENDICHTRING / OIL-SEAL*
270/300/15 A NBR WELLENDICHTRING / OIL-SEAL*
270/300/15 AS NBR WELLENDICHTRING / OIL-SEAL
270/310/16 AS NBR WELLENDICHTRING / OIL-SEAL
280/310/15 A NBR WELLENDICHTRING / OIL-SEAL*
280/310/16 AS NBR WELLENDICHTRING / OIL-SEAL
280/320/16 AS NBR WELLENDICHTRING / OIL-SEAL
280/320/20 A NBR WELLENDICHTRING / OIL-SEAL*
280/320/20 AS NBR WELLENDICHTRING / OIL-SEAL*
285/310/16 AS NBR WELLENDICHTRING / OIL-SEAL
285/325/16 AS NBR WELLENDICHTRING / OIL-SEAL
290/330/18 AS NBR WELLENDICHTRING / OIL-SEAL
300/332/16 AS NBR WELLENDICHTRING / OIL-SEAL
300/340/16 AS NBR WELLENDICHTRING / OIL-SEAL
300/340/18 A NBR WELLENDICHTRING / OIL-SEAL*
300/340/18 AS NBR WELLENDICHTRING / OIL-SEAL*
300/340/20 A NBR WELLENDICHTRING / OIL-SEAL*
300/340/20 AS NBR WELLENDICHTRING / OIL-SEAL*
310/340/15 AS NBR WELLENDICHTRING / OIL-SEAL*
310/350/20 AS NBR WELLENDICHTRING / OIL-SEAL
320/350/15 A NBR WELLENDICHTRING / OIL-SEAL
320/360/18 AS NBR WELLENDICHTRING / OIL-SEAL*
320/360/20 A NBR WELLENDICHTRING / OIL-SEAL*
320/360/20 AS NBR WELLENDICHTRING / OIL-SEAL*
330/370/18 A NBR WELLENDICHTRING / OIL-SEAL*
335/375/18 AS NBR WELLENDICHTRING / OIL-SEAL
340/380/18 A NBR WELLENDICHTRING / OIL-SEAL*
340/380/20 AS NBR WELLENDICHTRING / OIL-SEAL*
350/380/16 AS NBR WELLENDICHTRING / OIL-SEAL*
350/390/18 A NBR WELLENDICHTRING / OIL-SEAL*

350/390/18 AS NBR WELLENDICHTRING / OIL-SEAL
360/390/15 AS NBR WELLENDICHTRING / OIL-SEAL
360/390/16 A NBR WELLENDICHTRING / OIL-SEAL
360/400/16 A NBR WELLENDICHTRING / OIL-SEAL
360/400/20 A NBR WELLENDICHTRING / OIL-SEAL*
360/400/20 AS NBR WELLENDICHTRING / OIL-SEAL*
370/410/15 A NBR WELLENDICHTRING / OIL-SEAL*
380/420/20 A NBR WELLENDICHTRING / OIL-SEAL*
380/420/20 AS NBR WELLENDICHTRING / OIL-SEAL*
385/425/15 A NBR WELLENDICHTRING / OIL-SEAL
390/430/20 A NBR WELLENDICHTRING / OIL-SEAL
394/420/16 A NBR WELLENDICHTRING / OIL-SEAL*
394/420/16 AS NBR WELLENDICHTRING / OIL-SEAL*
394/420/16 AS-P NBR WELLENDICHTRING / OIL-SEAL
400/440/20 A NBR WELLENDICHTRING / OIL-SEAL*
400/440/20 AS NBR WELLENDICHTRING / OIL-SEAL
400/450/21 A NBR WELLENDICHTRING / OIL-SEAL
400/450/25 A-P NBR WELLENDICHTRING / OIL-SEAL
410/440/15 AS NBR WELLENDICHTRING / OIL-SEAL
420/460/20 A NBR WELLENDICHTRING / OIL-SEAL*
420/460/20 A NBR WELLENDICHTRING / OIL-SEAL
420/460/20 AS NBR WELLENDICHTRING / OIL-SEAL
420/470/20 AS NBR WELLENDICHTRING / OIL-SEAL*
440/480/20 A NBR WELLENDICHTRING / OIL-SEAL*
440/480/20 AS NBR WELLENDICHTRING / OIL-SEAL*
445/480/16 AS NBR WELLENDICHTRING / OIL-SEAL
450/500/20 A NBR WELLENDICHTRING / OIL-SEAL
450/500/22 A NBR WELLENDICHTRING / OIL-SEAL*
460/500/20 A NBR WELLENDICHTRING / OIL-SEAL
460/500/20 AS NBR WELLENDICHTRING / OIL-SEAL*
480/520/20 A NBR WELLENDICHTRING / OIL-SEAL*
480/520/20 AS NBR WELLENDICHTRING / OIL-SEAL*
480/530/25 A NBR WELLENDICHTRING / OIL-SEAL
485/515/15 AS NBR WELLENDICHTRING / OIL-SEAL
500/540/20 A NBR WELLENDICHTRING / OIL-SEAL*
500/540/20 A NBR WELLENDICHTRING / OIL-SEAL
500/540/20 AS NBR WELLENDICHTRING / OIL-SEAL*
560/600/18 A NBR WELLENDICHTRING / OIL-SEAL
560/610/20 A NBR WELLENDICHTRING / OIL-SEAL
600/640/20 A NBR WELLENDICHTRING / OIL-SEAL
670/710/20 A NBR WELLENDICHTRING / OIL-SEAL
800/840/20 A NBR WELLENDICHTRING / OIL-SEAL D.
860/900/20 A NBR WELLENDICHTRING / OIL-SEAL
15/28/5 A SIL WELLENDICHTRING / OIL-SEAL
65/85/10 A SIL WELLENDICHTRING / OIL-SEAL
75/95/10 A SIL WELLENDICHTRING / OIL-SEAL
80/100/10 A SIL WELLENDICHTRING / OIL-SEAL
80/100/10 AS SIL WELLENDICHTRING / OIL-SEAL
140/170/15 A SIL WELLENDICHTRING / OIL-SEAL
150/180/12 A SIL WELLENDICHTRING / OIL-SEAL

4/11/6 A FPM WELLENDICHTRING / OIL-SEAL*
4/12/6 A FPM WELLENDICHTRING / OIL-SEAL*
5/14/6 A FPM WELLENDICHTRING / OIL-SEAL
5/15/6 A FPM WELLENDICHTRING / OIL-SEAL*
5/16/7 A FPM WELLENDICHTRING / OIL-SEAL*
6/14/6 A FPM WELLENDICHTRING / OIL-SEAL*
6/15/4 A FPM WELLENDICHTRING / OIL-SEAL
6/16/5 AS FPM WELLENDICHTRING / OIL-SEAL
6/16/6 A FPM WELLENDICHTRING / OIL-SEAL*
6/16/7 A FPM WELLENDICHTRING / OIL-SEAL*
6/19/6 A FPM WELLENDICHTRING / OIL-SEAL*
6,35/19,05/6,35 A FPM WELLENDICHTRING / OIL-SEAL
6/20/6 A FPM WELLENDICHTRING / OIL-SEAL
6/22/7 A FPM WELLENDICHTRING / OIL-SEAL
7/16/7 A FPM WELLENDICHTRING / OIL-SEAL*
7/22/7 A FPM WELLENDICHTRING / OIL-SEAL
7/22/7 AS FPM WELLENDICHTRING / OIL-SEAL
8/16/7 A FPM WELLENDICHTRING / OIL-SEAL*
8/16/7 AS FPM WELLENDICHTRING / OIL-SEAL
8/18/5 A FPM WELLENDICHTRING / OIL-SEAL*
8/18/6 AS FPM WELLENDICHTRING / OIL-SEAL
8/22/6 AS-P FPM WELLENDICHTRING / OIL-SEAL*
8/22/7 A FPM WELLENDICHTRING / OIL-SEAL*
8/22/7 AS FPM WELLENDICHTRING / OIL-SEAL*
8/24/7 A FPM WELLENDICHTRING / OIL-SEAL*
9/22/7 A FPM WELLENDICHTRING / OIL-SEAL
9/24/7 A FPM WELLENDICHTRING / OIL-SEAL
10/16/4 A FPM WELLENDICHTRING / OIL-SEAL*
10/16/4 A-O FPM WELLENDICHTRING / OIL-SEAL
10/16/4 AS FPM WELLENDICHTRING / OIL-SEAL
10/19/7 A FPM WELLENDICHTRING / OIL-SEAL*
10/19/7 AS FPM WELLENDICHTRING / OIL-SEAL*
10/20/6 AS-P FPM WELLENDICHTRING / OIL-SEAL*
10/22/6 AS FPM WELLENDICHTRING / OIL-SEAL
10/22/6/6,5 AS-P FPM WELLENDICHTRING / OIL-SEAL
10/22/7 A FPM WELLENDICHTRING / OIL-SEAL*
10/22/7 AS FPM WELLENDICHTRING / OIL-SEAL
10/24/7 A FPM WELLENDICHTRING / OIL-SEAL*
10/24/7 AS FPM WELLENDICHTRING / OIL-SEAL
10/26/7 A FPM WELLENDICHTRING / OIL-SEAL*
10/26/7 A-DUO FPM WELLENDICHTRING / OIL-SEAL
10/26/7 AS FPM WELLENDICHTRING / OIL-SEAL
10/28/7 A FPM WELLENDICHTRING / OIL-SEAL*
10/28/7 AS FPM WELLENDICHTRING / OIL-SEAL
10/28/8 A FPM WELLENDICHTRING / OIL-SEAL
10/30/7 A FPM WELLENDICHTRING / OIL-SEAL*
11/22/7 A FPM WELLENDICHTRING / OIL-SEAL*
12/19/5 A FPM WELLENDICHTRING / OIL-SEAL*
12/19/5 AS FPM WELLENDICHTRING / OIL-SEAL
12/20/5 AS FPM WELLENDICHTRING / OIL-SEAL

12/22/4 A FPM WELLENDICHTRING / OIL-SEAL*
12/22/5 AS FPM WELLENDICHTRING / OIL-SEAL
12/22/6 AS-P FPM WELLENDICHTRING / OIL-SEAL*
12,7/22,23/6,35 AS FPM WELLENDICHTRING / OIL-SEAL
12/22/7 A FPM WELLENDICHTRING / OIL-SEAL*
12/22/7 AS FPM WELLENDICHTRING / OIL-SEAL*
12/22/7 AS-P FPM WELLENDICHTRING / OIL-SEAL
12/22/8 AS FPM WELLENDICHTRING / OIL-SEAL
12/24/6,5 A FPM WELLENDICHTRING / OIL-SEAL
12/24/6/6,5 AS-P FPM WELLENDICHTRING / OIL-SEAL
12/24/7 A FPM WELLENDICHTRING / OIL-SEAL*
12/24/7 AS FPM WELLENDICHTRING / OIL-SEAL*
12/24/7 AS-P FPM WELLENDICHTRING / OIL-SEAL*
12/25/5 AS FPM WELLENDICHTRING / OIL-SEAL
12/25/7 AS FPM WELLENDICHTRING / OIL-SEAL
12/25/7/7,5 AS-P FPM WELLENDICHTRING / OIL-SEAL
12/26/7 A-DUO FPM WELLENDICHTRING / OIL-SEAL
12/26/7 AS FPM WELLENDICHTRING / OIL-SEAL
12/28/7 A FPM WELLENDICHTRING / OIL-SEAL*
12/28/7 AS FPM WELLENDICHTRING / OIL-SEAL*
12/30/7 A FPM WELLENDICHTRING / OIL-SEAL*
12/30/10 A FPM WELLENDICHTRING / OIL-SEAL
12/32/7 AS FPM WELLENDICHTRING / OIL-SEAL
13/26/9 AS FPM WELLENDICHTRING / OIL-SEAL
14/22/4 A FPM WELLENDICHTRING / OIL-SEAL*
14/24/7 A FPM WELLENDICHTRING / OIL-SEAL*
14/24/7 AS FPM WELLENDICHTRING / OIL-SEAL
14/26/7 AS FPM WELLENDICHTRING / OIL-SEAL
14/27/7 AS FPM WELLENDICHTRING / OIL-SEAL
14/28/7 AS FPM WELLENDICHTRING / OIL-SEAL
14/30/7 A FPM WELLENDICHTRING / OIL-SEAL*
14/30/7 AS FPM WELLENDICHTRING / OIL-SEAL
15/24/5 A FPM WELLENDICHTRING / OIL-SEAL*
15/24/5 AS FPM WELLENDICHTRING / OIL-SEAL
15/24/7 A FPM WELLENDICHTRING / OIL-SEAL*
15/24/7 AS FPM WELLENDICHTRING / OIL-SEAL*
15/25/7 AS FPM WELLENDICHTRING / OIL-SEAL
15/26/7 A FPM WELLENDICHTRING / OIL-SEAL*
15/26/7 AS FPM WELLENDICHTRING / OIL-SEAL*
15/28/5 A FPM WELLENDICHTRING / OIL-SEAL
15/28/7 A FPM WELLENDICHTRING / OIL-SEAL*
15/28/7 AS FPM WELLENDICHTRING / OIL-SEAL
15/30/7 A FPM WELLENDICHTRING / OIL-SEAL*
15/30/7 AS FPM WELLENDICHTRING / OIL-SEAL
15/30/10 A FPM WELLENDICHTRING / OIL-SEAL*
15/30/10 AS FPM WELLENDICHTRING / OIL-SEAL
15/32/7 A FPM WELLENDICHTRING / OIL-SEAL*
15/32/7 AS FPM WELLENDICHTRING / OIL-SEAL*
15/35/6/6,5 AS-P FPM WELLENDICHTRING / OIL-SEAL
15/35/7 A FPM WELLENDICHTRING / OIL-SEAL*

15/42/7 A FPM WELLENDICHTRING / OIL-SEAL
16/22/4 A FPM WELLENDICHTRING / OIL-SEAL
16/24/4 A FPM WELLENDICHTRING / OIL-SEAL*
16/24/4 AS FPM WELLENDICHTRING / OIL-SEAL
16/24/5 A FPM WELLENDICHTRING / OIL-SEAL
16/24/5 AS FPM WELLENDICHTRING / OIL-SEAL
16/24/7 A-P FPM WELLENDICHTRING / OIL-SEAL,
16/26/7 A FPM WELLENDICHTRING / OIL-SEAL*
16/28/7 A FPM WELLENDICHTRING / OIL-SEAL*
16/28/7 AS FPM WELLENDICHTRING / OIL-SEAL*
16/28/7/7,5 AS-P FPM WELLENDICHTRING / OIL-SEAL
16/30/7 A FPM WELLENDICHTRING / OIL-SEAL*
16/32/8 A FPM WELLENDICHTRING / OIL-SEAL
17/25/4 A FPM WELLENDICHTRING / OIL-SEAL
17/28/5 AS FPM WELLENDICHTRING / OIL-SEAL
17/28/6 AS FPM WELLENDICHTRING / OIL-SEAL*
17/28/6,5 AS FPM (st) WELLENDICHTRING / OIL-SEAL
17/28/7 A FPM WELLENDICHTRING / OIL-SEAL*
17/28/7 AS FPM WELLENDICHTRING / OIL-SEAL*
17/28/7 AS-P FPM WELLENDICHTRING / OIL-SEAL
17/28/8 A FPM WELLENDICHTRING / OIL-SEAL
17/28/8 A-DUO FPM WELLENDICHTRING / OIL-SEAL
17/30/6/6,5 AS-P FPM WELLENDICHTRING / OIL-SEAL*
17/30/7 A FPM WELLENDICHTRING / OIL-SEAL*
17/30/7 A-DUO FPM WELLENDICHTRING / OIL-SEAL
17/30/7 AS FPM WELLENDICHTRING / OIL-SEAL*
17/32/7 A FPM WELLENDICHTRING / OIL-SEAL*
17/32/7 AS FPM WELLENDICHTRING / OIL-SEAL
17/32/10 A FPM WELLENDICHTRING / OIL-SEAL
17/35/7 A FPM WELLENDICHTRING / OIL-SEAL*
17/35/7 AS FPM WELLENDICHTRING / OIL-SEAL*
17/35/7 AS-P FPM WELLENDICHTRING / OIL-SEAL
17/35/10 A FPM WELLENDICHTRING / OIL-SEAL*
17/40/7 A FPM WELLENDICHTRING / OIL-SEAL*
17/40/7 AS FPM WELLENDICHTRING / OIL-SEAL
18/28/6 A FPM WELLENDICHTRING / OIL-SEAL
18/28/7 A FPM WELLENDICHTRING / OIL-SEAL*
18/28/7 AS FPM WELLENDICHTRING / OIL-SEAL
18/28/8 A FPM WELLENDICHTRING / OIL-SEAL
18/30/7 A FPM WELLENDICHTRING / OIL-SEAL*
18/30/7 AS FPM WELLENDICHTRING / OIL-SEAL*
18/30/7/7,5 AS-P FPM WELLENDICHTRING / OIL-SEAL
18/32/7 A FPM WELLENDICHTRING / OIL-SEAL*
18/32/7 AS FPM WELLENDICHTRING / OIL-SEAL
18/35/6 AS-P FPM WELLENDICHTRING / OIL-SEAL
18/35/7 AS FPM WELLENDICHTRING / OIL-SEAL
18/35/8 A FPM WELLENDICHTRING / OIL-SEAL
18/35/10 A FPM WELLENDICHTRING / OIL-SEAL*
18/40/7 A FPM WELLENDICHTRING / OIL-SEAL*
19,05/31,75/6,3 AS FPM WELLENDICHTRING / OIL-SEAL

20/30/5 A FPM WELLENDICHTRING / OIL-SEAL*
20/30/7 A FPM WELLENDICHTRING / OIL-SEAL*
20/30/7 A-P FPM WELLENDICHTRING / OIL-SEAL
20/30/7 AS FPM WELLENDICHTRING / OIL-SEAL*
20/30/7 AS-P FPM WELLENDICHTRING / OIL-SEAL*
20/32/6/6,5 AS-P FPM WELLENDICHTRING / OIL-SEAL
20/32/7 A FPM WELLENDICHTRING / OIL-SEAL*
20/32/7 AS FPM WELLENDICHTRING / OIL-SEAL*
20/32/8 AS FPM WELLENDICHTRING / OIL-SEAL
20/33/10 A FPM WELLENDICHTRING / OIL-SEAL*
20/35/5 A FPM WELLENDICHTRING / OIL-SEAL
20/35/6 AS-P FPM WELLENDICHTRING / OIL-SEAL*
20/35/7 A FPM WELLENDICHTRING / OIL-SEAL*
20/35/7 AS FPM WELLENDICHTRING / OIL-SEAL*
20/35/10 A FPM WELLENDICHTRING / OIL-SEAL*
20/38/8 A FPM WELLENDICHTRING / OIL-SEAL
20/40/7 A FPM WELLENDICHTRING / OIL-SEAL*
20/40/7 AS FPM WELLENDICHTRING / OIL-SEAL*
20/40/10 A FPM WELLENDICHTRING / OIL-SEAL*
20/42/7 A FPM WELLENDICHTRING / OIL-SEAL*
20/42/7 AS FPM WELLENDICHTRING / OIL-SEAL*
20/42/10 A FPM WELLENDICHTRING / OIL-SEAL*
20/47/7 A FPM WELLENDICHTRING / OIL-SEAL*
20/47/10 A FPM WELLENDICHTRING / OIL-SEAL*
20/52/7 A FPM WELLENDICHTRING / OIL-SEAL*
20/52/8 AS FPM WELLENDICHTRING / OIL-SEAL
22/30/7 A FPM WELLENDICHTRING / OIL-SEAL
22/32/6/6,5 AS-P FPM WELLENDICHTRING / OIL-SEAL
22/32/7 A FPM WELLENDICHTRING / OIL-SEAL*
22/32/7 AS FPM WELLENDICHTRING / OIL-SEAL*
22/35/7 A FPM WELLENDICHTRING / OIL-SEAL*
22/35/7 AS FPM WELLENDICHTRING / OIL-SEAL*
22/35/7/7,5 AS-P FPM WELLENDICHTRING / OIL-SEAL
22/35/8 A FPM WELLENDICHTRING / OIL-SEAL*
22,23/35,15/9,5 A FPM WELLENDICHTRING / OIL-SEAL
22/36/7 AS FPM WELLENDICHTRING / OIL-SEAL
22/37/7 AS FPM WELLENDICHTRING / OIL-SEAL
22/38/7 A FPM WELLENDICHTRING / OIL-SEAL
22/40/7 A FPM WELLENDICHTRING / OIL-SEAL*
22/40/7 A FPM WELLENDICHTRING / OIL-SEAL*
22/40/7 A-DUO FPM WELLENDICHTRING / OIL-SEAL
22/40/7 AS FPM WELLENDICHTRING / OIL-SEAL*
22/40/10 A FPM WELLENDICHTRING / OIL-SEAL*
22/47/7 A FPM WELLENDICHTRING / OIL-SEAL*
22/47/7/7,5 AS-P FPM WELLENDICHTRING / OIL-SEAL
24/35/6 AS FPM WELLENDICHTRING / OIL-SEAL
24/35/7 A FPM WELLENDICHTRING / OIL-SEAL*
24/35/7 AS FPM WELLENDICHTRING / OIL-SEAL
24/36/7 AS FPM WELLENDICHTRING / OIL-SEAL*
24/37/7 A FPM WELLENDICHTRING / OIL-SEAL*

24/40/7 A FPM WELLENDICHTRING / OIL-SEAL*
24/40/7 AS FPM WELLENDICHTRING / OIL-SEAL*
24/47/10 AS FPM WELLENDICHTRING / OIL-SEAL
25/32/4 AS FPM WELLENDICHTRING / OIL-SEAL
25/32/6 A FPM WELLENDICHTRING / OIL-SEAL*
25/32/6 AS FPM WELLENDICHTRING / OIL-SEAL
25/33/6 A FPM WELLENDICHTRING / OIL-SEAL*
25/35/6 AS-P FPM WELLENDICHTRING / OIL-SEAL*
25/35/7 A FPM WELLENDICHTRING / OIL-SEAL*
25/35/7 AS FPM WELLENDICHTRING / OIL-SEAL*
25/37/5 A FPM WELLENDICHTRING / OIL-SEAL*
25/37/6 AS FPM WELLENDICHTRING / OIL-SEAL
25/37/6/6,5 AS-P FPM WELLENDICHTRING / OIL-SEAL
25/37/7 AS FPM WELLENDICHTRING / OIL-SEAL*
25/38/7 A FPM WELLENDICHTRING / OIL-SEAL*
25/38/7 AS FPM WELLENDICHTRING / OIL-SEAL
25/40/7 A FPM WELLENDICHTRING / OIL-SEAL*
25/40/7 AS FPM WELLENDICHTRING / OIL-SEAL*
25/40/7 AS-P FPM WELLENDICHTRING / OIL-SEAL
25/40/8 AS FPM WELLENDICHTRING / OIL-SEAL
25/40/10 A FPM WELLENDICHTRING / OIL-SEAL*
25/40/10 AS FPM WELLENDICHTRING / OIL-SEAL
25/42/6 AS FPM WELLENDICHTRING / OIL-SEAL
25/42/7 A FPM WELLENDICHTRING / OIL-SEAL*
25/42/7 AS FPM WELLENDICHTRING / OIL-SEAL*
25/42/10 A FPM WELLENDICHTRING / OIL-SEAL*
25,4/44,45/9,52 AS FPM WELLENDICHTRING / OIL-SEAL
25/45/7 A FPM WELLENDICHTRING / OIL-SEAL
25/45/10 A FPM WELLENDICHTRING / OIL-SEAL*
25/45/10 AS FPM WELLENDICHTRING / OIL-SEAL
25/46/7 A FPM WELLENDICHTRING / OIL-SEAL
25/47/7 A FPM WELLENDICHTRING / OIL-SEAL*
25/47/7 AS FPM WELLENDICHTRING / OIL-SEAL*
25/47/8 A FPM WELLENDICHTRING / OIL-SEAL*
25/47/10 A FPM WELLENDICHTRING / OIL-SEAL*
25/50/7 A FPM WELLENDICHTRING / OIL-SEAL
25/50/10 A FPM WELLENDICHTRING / OIL-SEAL
25/50/10 AS FPM WELLENDICHTRING / OIL-SEAL
25/52/7 A FPM WELLENDICHTRING / OIL-SEAL*
25/52/7 AS FPM WELLENDICHTRING / OIL-SEAL*
25/52/10 A FPM WELLENDICHTRING / OIL-SEAL*
25/62/7 A FPM WELLENDICHTRING / OIL-SEAL*
25/62/7 AS FPM WELLENDICHTRING / OIL-SEAL
25/62/10 A FPM WELLENDICHTRING / OIL-SEAL*
26/35/7 AS FPM WELLENDICHTRING / OIL-SEAL
26/36/7 AS FPM WELLENDICHTRING / OIL-SEAL
26/37/7 A FPM WELLENDICHTRING / OIL-SEAL
26/37/7 AS FPM WELLENDICHTRING / OIL-SEAL
26/37/7/7,5 AS-P FPM WELLENDICHTRING / OIL-SEAL
26/40/6/6,5 AS-P FPM WELLENDICHTRING / OIL-SEAL

26/42/7 AS FPM WELLENDICHTRING / OIL-SEAL*
26/47/7 A FPM WELLENDICHTRING / OIL-SEAL*
26/47/7 AS FPM WELLENDICHTRING / OIL-SEAL
26,99/47,63/9,53 A FPM WELLENDICHTRING / OIL-SEAL
27/37/7 A FPM WELLENDICHTRING / OIL-SEAL*
27/41/10 A FPM WELLENDICHTRING / OIL-SEAL
28/38/7 A FPM WELLENDICHTRING / OIL-SEAL*
28/38/7 AS FPM WELLENDICHTRING / OIL-SEAL
28/40/6/6,5 AS-P FPM WELLENDICHTRING / OIL-SEAL
28/40/7 A FPM WELLENDICHTRING / OIL-SEAL*
28/40/7 AS FPM WELLENDICHTRING / OIL-SEAL*
28/40/10 A FPM WELLENDICHTRING / OIL-SEAL
28/42/10 A FPM WELLENDICHTRING / OIL-SEAL
28/45/7 A FPM WELLENDICHTRING / OIL-SEAL*
28/45/9 A FPM WELLENDICHTRING / OIL-SEAL
28/47/7 A FPM WELLENDICHTRING / OIL-SEAL*
28/47/7 AS FPM WELLENDICHTRING / OIL-SEAL*
28/47/8 AS FPM WELLENDICHTRING / OIL-SEAL
28/47/10 A FPM WELLENDICHTRING / OIL-SEAL*
28/47/10 AS FPM WELLENDICHTRING / OIL-SEAL
28/50/10 A FPM WELLENDICHTRING / OIL-SEAL
28/52/7 A FPM WELLENDICHTRING / OIL-SEAL*
28/52/7 AS FPM WELLENDICHTRING / OIL-SEAL
30/40/4 AS FPM WELLENDICHTRING / OIL-SEAL
30/40/5 A FPM WELLENDICHTRING / OIL-SEAL*
30/40/7 A FPM WELLENDICHTRING / OIL-SEAL*
30/40/7 AS FPM WELLENDICHTRING / OIL-SEAL*
30/40/7 AS-P FPM WELLENDICHTRING / OIL-SEAL*
30/42/6 AS FPM WELLENDICHTRING / OIL-SEAL
30/42/6 AS-P FPM WELLENDICHTRING / OIL-SEAL*
30/42/7 A FPM WELLENDICHTRING / OIL-SEAL*
30/42/7 AS FPM WELLENDICHTRING / OIL-SEAL*
30/45/7 A FPM WELLENDICHTRING / OIL-SEAL*
30/45/7 AS FPM WELLENDICHTRING / OIL-SEAL
30/45/7/7,5 AS-P FPM WELLENDICHTRING / OIL-SEAL
30/45/8 A FPM WELLENDICHTRING / OIL-SEAL*
30/45/10 A FPM WELLENDICHTRING / OIL-SEAL*
30/47/7 A FPM WELLENDICHTRING / OIL-SEAL*
30/47/7 AS FPM WELLENDICHTRING / OIL-SEAL*
30/47/7 AS-P FPM WELLENDICHTRING / OIL-SEAL
30/47/10 A FPM WELLENDICHTRING / OIL-SEAL*
30/47/10 AS FPM WELLENDICHTRING / OIL-SEAL
30/50/7 A FPM WELLENDICHTRING / OIL-SEAL
30/50/7 AS FPM WELLENDICHTRING / OIL-SEAL
30/50/10 A FPM WELLENDICHTRING / OIL-SEAL*
30/50/10 AS FPM WELLENDICHTRING / OIL-SEAL*
30/52/5 A FPM WELLENDICHTRING / OIL-SEAL
30/52/7 A FPM WELLENDICHTRING / OIL-SEAL*
30/52/7 AS FPM WELLENDICHTRING / OIL-SEAL*
30/52/7/7,5 AS-P FPM WELLENDICHTRING / OIL-SEAL

30/52/10 A FPM WELLENDICHTRING / OIL-SEAL*
30/52/10 AS FPM WELLENDICHTRING / OIL-SEAL*
30/55/7 A FPM WELLENDICHTRING / OIL-SEAL*
30/55/7 AS FPM WELLENDICHTRING / OIL-SEAL
30/55/10 A FPM WELLENDICHTRING / OIL-SEAL*
30/55/10 AS FPM WELLENDICHTRING / OIL-SEAL*
30/55/5,5/6 AS-P FPM WELLENDICHTRING / OIL-SEAL
30/56/10 A FPM WELLENDICHTRING / OIL-SEAL*
30/60/10 AS FPM WELLENDICHTRING / OIL-SEAL
30/62/7 A FPM WELLENDICHTRING / OIL-SEAL*
30/62/7 AS FPM WELLENDICHTRING / OIL-SEAL*
30/62/10 A FPM WELLENDICHTRING / OIL-SEAL*
30/72/8 AS FPM WELLENDICHTRING / OIL-SEAL*
30/72/10 AS FPM WELLENDICHTRING / OIL-SEAL
32/45/7 A FPM WELLENDICHTRING / OIL-SEAL*
32/45/7 AS FPM WELLENDICHTRING / OIL-SEAL
32/47/6 A FPM WELLENDICHTRING / OIL-SEAL
32/47/6 AS FPM WELLENDICHTRING / OIL-SEAL
32/47/7 A FPM WELLENDICHTRING / OIL-SEAL*
32/47/7 AS FPM WELLENDICHTRING / OIL-SEAL*
32/48/8 A FPM WELLENDICHTRING / OIL-SEAL*
32/50/7 AS FPM WELLENDICHTRING / OIL-SEAL
32/50/10 A FPM WELLENDICHTRING / OIL-SEAL*
32/52/7 A FPM WELLENDICHTRING / OIL-SEAL*
32/52/7 AS FPM WELLENDICHTRING / OIL-SEAL*
32/52/10 A FPM WELLENDICHTRING / OIL-SEAL*
32/55/9/9,5 AS-P FPM WELLENDICHTRING / OIL-SEAL
33/45/7 A FPM WELLENDICHTRING / OIL-SEAL*
34/46/8 AS FPM WELLENDICHTRING / OIL-SEAL
34/52/8 A FPM WELLENDICHTRING / OIL-SEAL
35/44/7 A FPM WELLENDICHTRING / OIL-SEAL*
35/45/7 A FPM WELLENDICHTRING / OIL-SEAL*
35/45/7 AS FPM WELLENDICHTRING / OIL-SEAL
35/47/6/6,5 AS-P FPM WELLENDICHTRING / OIL-SEAL*
35/47/7 A FPM WELLENDICHTRING / OIL-SEAL*
35/47/7 AS FPM WELLENDICHTRING / OIL-SEAL*
35/47/7 AS-P FPM WELLENDICHTRING / OIL-SEAL
35/50/7 A FPM WELLENDICHTRING / OIL-SEAL*
35/50/8 A FPM WELLENDICHTRING / OIL-SEAL*
35/50/8 AS FPM WELLENDICHTRING / OIL-SEAL*
35/50/10 A FPM WELLENDICHTRING / OIL-SEAL*
35/50/10 AS FPM WELLENDICHTRING / OIL-SEAL
35/52/6 AS FPM WELLENDICHTRING / OIL-SEAL*
35/52/6/6,5 AS-P FPM WELLENDICHTRING / OIL-SEAL*
35/52/7 A FPM WELLENDICHTRING / OIL-SEAL*
35/52/7 AS FPM WELLENDICHTRING / OIL-SEAL*
35/52/9 AS FPM WELLENDICHTRING / OIL-SEAL
35/52/10 A FPM WELLENDICHTRING / OIL-SEAL*
35/52/10 AS FPM WELLENDICHTRING / OIL-SEAL*
35/55/7 A FPM WELLENDICHTRING / OIL-SEAL

35/55/7 AS FPM WELLENDICHTRING / OIL-SEAL
35/55/8 A FPM WELLENDICHTRING / OIL-SEAL
35/55/10 A FPM WELLENDICHTRING / OIL-SEAL*
35/55/10 AS FPM WELLENDICHTRING / OIL-SEAL*
35/55/10 AS-P FPM WELLENDICHTRING / OIL-SEAL
35/56/10 A FPM WELLENDICHTRING / OIL-SEAL*
35/60/10 AS FPM WELLENDICHTRING / OIL-SEAL
35/62/7 A FPM WELLENDICHTRING / OIL-SEAL*
35/62/7 AS FPM WELLENDICHTRING / OIL-SEAL*
35/62/10 A FPM WELLENDICHTRING / OIL-SEAL*
35/62/10 AS FPM WELLENDICHTRING / OIL-SEAL*
35/68/10 A FPM WELLENDICHTRING / OIL-SEAL*
35/72/8 AS FPM WELLENDICHTRING / OIL-SEAL
35/72/10 A FPM WELLENDICHTRING / OIL-SEAL*
35/72/10 AS FPM WELLENDICHTRING / OIL-SEAL
35/80/10 AS FPM WELLENDICHTRING / OIL-SEAL
36/47/7 AS FPM WELLENDICHTRING / OIL-SEAL
36/48/10 A FPM WELLENDICHTRING / OIL-SEAL
36/50/7 A FPM WELLENDICHTRING / OIL-SEAL*
36/50/7 AS FPM WELLENDICHTRING / OIL-SEAL
36/52/7 AS FPM WELLENDICHTRING / OIL-SEAL*
36/54/7,5 A FPM WELLENDICHTRING / OIL-SEAL*
36/62/7 A FPM WELLENDICHTRING / OIL-SEAL
36/62/7 AS FPM WELLENDICHTRING / OIL-SEAL*
37/52/10 A FPM WELLENDICHTRING / OIL-SEAL
38/50/7 A FPM WELLENDICHTRING / OIL-SEAL*
38/50/7 AS FPM WELLENDICHTRING / OIL-SEAL
38/52/7 A FPM WELLENDICHTRING / OIL-SEAL*
38/52/7 AS FPM WELLENDICHTRING / OIL-SEAL*
38/54/6,5 A FPM WELLENDICHTRING / OIL-SEAL*
38/55/7 A FPM WELLENDICHTRING / OIL-SEAL*
38/55/7 AS FPM WELLENDICHTRING / OIL-SEAL
38/56/10 A FPM WELLENDICHTRING / OIL-SEAL*
38/56/10 AS FPM WELLENDICHTRING / OIL-SEAL
38/62/7 AS FPM WELLENDICHTRING / OIL-SEAL*
38/62/10 A FPM WELLENDICHTRING / OIL-SEAL*
38/62/10 AS FPM WELLENDICHTRING / OIL-SEAL*
38/62/12 AS FPM WELLENDICHTRING / OIL-SEAL
40/50/7 AS FPM WELLENDICHTRING / OIL-SEAL*
40/50/8 A FPM WELLENDICHTRING / OIL-SEAL
40/52/5/5,5 AS-P FPM WELLENDICHTRING / OIL-SEAL*
40/52/6 A FPM WELLENDICHTRING / OIL-SEAL
40/52/7 A FPM WELLENDICHTRING / OIL-SEAL*
40/52/7 AS FPM WELLENDICHTRING / OIL-SEAL*
40/52/7 AS-P FPM WELLENDICHTRING / OIL-SEAL*
40/55/6 AS FPM WELLENDICHTRING / OIL-SEAL
40/55/7 A FPM WELLENDICHTRING / OIL-SEAL*
40/55/7/7,5 AS-P FPM WELLENDICHTRING / OIL-SEAL*
40/55/8 A FPM WELLENDICHTRING / OIL-SEAL*
40/55/8 AS FPM WELLENDICHTRING / OIL-SEAL*

40/55/10 AS FPM WELLENDICHTRING / OIL-SEAL
40/56/8 A FPM WELLENDICHTRING / OIL-SEAL*
40/56/8 AS FPM WELLENDICHTRING / OIL-SEAL
40/56/10 A FPM WELLENDICHTRING / OIL-SEAL*
40/58/6/6,5 AS-P FPM WELLENDICHTRING / OIL-SEAL
40/58/10 A FPM WELLENDICHTRING / OIL-SEAL*
40/58/10 AS FPM WELLENDICHTRING / OIL-SEAL*
40/60/7 A FPM WELLENDICHTRING / OIL-SEAL
40/60/7 AS FPM WELLENDICHTRING / OIL-SEAL
40/60/10 A FPM WELLENDICHTRING / OIL-SEAL*
40/60/10 AS FPM WELLENDICHTRING / OIL-SEAL*
40/62/6 AS-P FPM WELLENDICHTRING / OIL-SEAL*
40/62/7 A FPM WELLENDICHTRING / OIL-SEAL*
40/62/7 AS FPM WELLENDICHTRING / OIL-SEAL*
40/62/8 AS FPM WELLENDICHTRING / OIL-SEAL
40/62/10 A FPM WELLENDICHTRING / OIL-SEAL*
40/62/10 AS FPM WELLENDICHTRING / OIL-SEAL*
40/62/12 A FPM WELLENDICHTRING / OIL-SEAL*
40/62/12 AS FPM WELLENDICHTRING / OIL-SEAL
40/65/10 A FPM WELLENDICHTRING / OIL-SEAL*
40/68/10 A FPM WELLENDICHTRING / OIL-SEAL*
40/68/10 AS FPM WELLENDICHTRING / OIL-SEAL
40/70/10 A FPM WELLENDICHTRING / OIL-SEAL
40/72/7 A FPM WELLENDICHTRING / OIL-SEAL*
40/72/7 AS FPM WELLENDICHTRING / OIL-SEAL*
40/72/10 A FPM WELLENDICHTRING / OIL-SEAL*
40/72/10 AS FPM WELLENDICHTRING / OIL-SEAL*
40/80/10 A FPM WELLENDICHTRING / OIL-SEAL*
40/80/10 AS FPM WELLENDICHTRING / OIL-SEAL*
40/85/10 A FPM WELLENDICHTRING / OIL-SEAL*
40/85/10 AS FPM WELLENDICHTRING / OIL-SEAL
40/90/10 AS FPM WELLENDICHTRING / OIL-SEAL
40/90/12 AS FPM WELLENDICHTRING / OIL-SEAL*
42/52/8 AS FPM WELLENDICHTRING / OIL-SEAL
42/55/7 AS FPM WELLENDICHTRING / OIL-SEAL*
42/55/8 A FPM WELLENDICHTRING / OIL-SEAL*
42/56/7 A FPM WELLENDICHTRING / OIL-SEAL*
42/56/7 AS FPM WELLENDICHTRING / OIL-SEAL
42/60/10 A FPM WELLENDICHTRING / OIL-SEAL*
42/60/12 A FPM WELLENDICHTRING / OIL-SEAL
42/62/7 A FPM WELLENDICHTRING / OIL-SEAL*
42/62/7/7,5 AS-P FPM WELLENDICHTRING / OIL-SEAL
42/62/8 A FPM WELLENDICHTRING / OIL-SEAL*
42/62/8 AS FPM WELLENDICHTRING / OIL-SEAL*
42/62/10 A FPM WELLENDICHTRING / OIL-SEAL*
42/65/10 A FPM WELLENDICHTRING / OIL-SEAL*
42/72/8 A FPM WELLENDICHTRING / OIL-SEAL
42/72/8 AS FPM WELLENDICHTRING / OIL-SEAL
42/72/10 A FPM WELLENDICHTRING / OIL-SEAL
44/65/8 AS FPM WELLENDICHTRING / OIL-SEAL

44/65/10 A FPM WELLENDICHTRING / OIL-SEAL
45/55/7 A FPM WELLENDICHTRING / OIL-SEAL*
45/55/7 AS FPM WELLENDICHTRING / OIL-SEAL
45/58/7 A FPM WELLENDICHTRING / OIL-SEAL*
45/58/7/7,5 AS-P FPM WELLENDICHTRING / OIL-SEAL
45/60/7 A FPM WELLENDICHTRING / OIL-SEAL*
45/60/7 AS FPM WELLENDICHTRING / OIL-SEAL
45/60/8 A FPM WELLENDICHTRING / OIL-SEAL*
45/60/8 AS FPM WELLENDICHTRING / OIL-SEAL*
45/60/10 A FPM WELLENDICHTRING / OIL-SEAL*
45/60/10 AS FPM WELLENDICHTRING / OIL-SEAL
45/62/7 A FPM WELLENDICHTRING / OIL-SEAL*
45/62/7 AS FPM WELLENDICHTRING / OIL-SEAL*
45/62/7 AS-P FPM WELLENDICHTRING / OIL-SEAL*
45/62/8 A FPM WELLENDICHTRING / OIL-SEAL*
45/62/8 AS FPM WELLENDICHTRING / OIL-SEAL*
45/62/10 A FPM WELLENDICHTRING / OIL-SEAL*
45/62/10 AS FPM WELLENDICHTRING / OIL-SEAL*
45/62/12 A FPM WELLENDICHTRING / OIL-SEAL
45/65/7 AS FPM WELLENDICHTRING / OIL-SEAL
45/65/7 AS-P FPM WELLENDICHTRING / OIL-SEAL*
45/65/8 A FPM WELLENDICHTRING / OIL-SEAL*
45/65/8 AS FPM WELLENDICHTRING / OIL-SEAL*
45/65/10 A FPM WELLENDICHTRING / OIL-SEAL*
45/65/10 AS FPM WELLENDICHTRING / OIL-SEAL*
45/68/10 A FPM WELLENDICHTRING / OIL-SEAL*
45/70/10 AS FPM WELLENDICHTRING / OIL-SEAL
45/70/12 A FPM WELLENDICHTRING / OIL-SEAL
45/72/8 A FPM WELLENDICHTRING / OIL-SEAL*
45/72/8 AS FPM WELLENDICHTRING / OIL-SEAL*
45/72/10 A FPM WELLENDICHTRING / OIL-SEAL*
45/75/10 A FPM WELLENDICHTRING / OIL-SEAL*
45/75/10 AS FPM WELLENDICHTRING / OIL-SEAL*
45/80/10 A FPM WELLENDICHTRING / OIL-SEAL*
45/80/10 AS FPM WELLENDICHTRING / OIL-SEAL*
45/85/10 AS FPM WELLENDICHTRING / OIL-SEAL*
45/90/10 AS FPM WELLENDICHTRING / OIL-SEAL
47/62/7 AS-P FPM WELLENDICHTRING / OIL-SEAL*
48/62/8 A FPM WELLENDICHTRING / OIL-SEAL*
48/62/8 AS FPM WELLENDICHTRING / OIL-SEAL*
48/65/7 A FPM WELLENDICHTRING / OIL-SEAL
48/65/8 AS FPM WELLENDICHTRING / OIL-SEAL
48/65/10 A FPM WELLENDICHTRING / OIL-SEAL*
48/65/10 AS FPM WELLENDICHTRING / OIL-SEAL*
48/72/8 A FPM WELLENDICHTRING / OIL-SEAL*
48/72/8 AS FPM WELLENDICHTRING / OIL-SEAL*
48/72/10 A FPM WELLENDICHTRING / OIL-SEAL*
48/72/10 AS FPM WELLENDICHTRING / OIL-SEAL
48/80/10 A FPM WELLENDICHTRING / OIL-SEAL*
50/60/7 A FPM WELLENDICHTRING / OIL-SEAL*

50/62/7 A FPM WELLENDICHTRING / OIL-SEAL*
50/65/7 AS-P FPM WELLENDICHTRING / OIL-SEAL*
50/65/8 A FPM WELLENDICHTRING / OIL-SEAL*
50/65/8 AS FPM WELLENDICHTRING / OIL-SEAL*
50/65/10 A FPM WELLENDICHTRING / OIL-SEAL*
50/65/10 AS FPM WELLENDICHTRING / OIL-SEAL
50/68/7/7,5 AS-P FPM WELLENDICHTRING / OIL-SEAL
50/68/8 A FPM WELLENDICHTRING / OIL-SEAL*
50/68/8 AS FPM WELLENDICHTRING / OIL-SEAL*
50/68/10 A FPM WELLENDICHTRING / OIL-SEAL*
50/68/10 AS FPM WELLENDICHTRING / OIL-SEAL*
50,8/69,85/9,52 A FPM WELLENDICHTRING / OIL-SEAL
50/70/10 A FPM WELLENDICHTRING / OIL-SEAL*
50/70/12 A FPM WELLENDICHTRING / OIL-SEAL*
50/70/12 AS FPM WELLENDICHTRING / OIL-SEAL
50/72/7 AS FPM WELLENDICHTRING / OIL-SEAL*
50/72/7 AS-P FPM WELLENDICHTRING / OIL-SEAL*
50/72/8 A FPM WELLENDICHTRING / OIL-SEAL*
50/72/8 AS FPM WELLENDICHTRING / OIL-SEAL*
50/72/10 A FPM WELLENDICHTRING / OIL-SEAL*
50/72/10 AS FPM WELLENDICHTRING / OIL-SEAL*
50/72/12 A FPM WELLENDICHTRING / OIL-SEAL*
50/72/12 AS FPM WELLENDICHTRING / OIL-SEAL*
50/75/10 A FPM WELLENDICHTRING / OIL-SEAL*
50/75/10 AS FPM WELLENDICHTRING / OIL-SEAL
50/80/7/7,5 AS-P FPM WELLENDICHTRING / OIL-SEAL
50/80/8 A FPM WELLENDICHTRING / OIL-SEAL*
50/80/8 AS FPM WELLENDICHTRING / OIL-SEAL*
50/80/10 A FPM WELLENDICHTRING / OIL-SEAL*
50/80/10 AS FPM WELLENDICHTRING / OIL-SEAL*
50/80/13 AS FPM WELLENDICHTRING / OIL-SEAL*
50/85/10 AS FPM WELLENDICHTRING / OIL-SEAL
50/90/10 A FPM WELLENDICHTRING / OIL-SEAL*
50/90/10 AS FPM WELLENDICHTRING / OIL-SEAL
52/62/8 A FPM WELLENDICHTRING / OIL-SEAL*
52/68/8 A FPM WELLENDICHTRING / OIL-SEAL*
52/68/8 AS FPM WELLENDICHTRING / OIL-SEAL
52/70/8 AS FPM WELLENDICHTRING / OIL-SEAL
52/72/7/7,5 AS-P FPM WELLENDICHTRING / OIL-SEAL
52/72/8 A FPM WELLENDICHTRING / OIL-SEAL*
52/72/10 A FPM WELLENDICHTRING / OIL-SEAL*
52/75/10 A FPM WELLENDICHTRING / OIL-SEAL
52/75/12 A FPM WELLENDICHTRING / OIL-SEAL*
54/70/12 A FPM WELLENDICHTRING / OIL-SEAL*
55/68/8 A FPM WELLENDICHTRING / OIL-SEAL*
55/68/8 AS FPM WELLENDICHTRING / OIL-SEAL*
55/70/8 A FPM WELLENDICHTRING / OIL-SEAL*
55/70/8 AS FPM WELLENDICHTRING / OIL-SEAL*
55/70/8 AS-P FPM WELLENDICHTRING / OIL-SEAL
55/70/10 A FPM WELLENDICHTRING / OIL-SEAL*

55/70/10/11 AS-P FPM WELLENDICHTRING / OIL-SEAL
55/72/7 AS-P FPM WELLENDICHTRING / OIL-SEAL*
55/72/8 A FPM WELLENDICHTRING / OIL-SEAL*
55/72/8 AS FPM WELLENDICHTRING / OIL-SEAL*
55/72/10 A FPM WELLENDICHTRING / OIL-SEAL*
55/72/10 AS FPM WELLENDICHTRING / OIL-SEAL*
55/75/7 AS-P FPM WELLENDICHTRING / OIL-SEAL*
55/75/8 AS FPM WELLENDICHTRING / OIL-SEAL
55/75/10 A FPM WELLENDICHTRING / OIL-SEAL*
55/75/12 A FPM WELLENDICHTRING / OIL-SEAL*
55/78/12 AS FPM WELLENDICHTRING / OIL-SEAL
55/80/8 A FPM WELLENDICHTRING / OIL-SEAL*
55/80/8 AS FPM WELLENDICHTRING / OIL-SEAL*
55/80/10 A FPM WELLENDICHTRING / OIL-SEAL*
55/80/10 AS FPM WELLENDICHTRING / OIL-SEAL*
55/85/10 A FPM WELLENDICHTRING / OIL-SEAL*
55/85/10 AS FPM WELLENDICHTRING / OIL-SEAL
55/90/7/7,5 AS-P FPM WELLENDICHTRING / OIL-SEAL
55/90/10 A FPM WELLENDICHTRING / OIL-SEAL*
55/90/10 AS FPM WELLENDICHTRING / OIL-SEAL*
55/100/10 AS FPM WELLENDICHTRING / OIL-SEAL
55/100/13 A FPM WELLENDICHTRING / OIL-SEAL
56/72/8 AS FPM WELLENDICHTRING / OIL-SEAL
56/72/8 AS-P FPM WELLENDICHTRING / OIL-SEAL
56/85/8 A FPM WELLENDICHTRING / OIL-SEAL
58/72/8 A FPM WELLENDICHTRING / OIL-SEAL*
58/72/8 AS FPM WELLENDICHTRING / OIL-SEAL
58/72/10 A FPM WELLENDICHTRING / OIL-SEAL*
58/80/8 A FPM WELLENDICHTRING / OIL-SEAL*
58/80/9 AS FPM WELLENDICHTRING / OIL-SEAL
58/80/10 A FPM WELLENDICHTRING / OIL-SEAL*
58/80/10 AS-P FPM WELLENDICHTRING / OIL-SEAL*
60/72/8 A FPM WELLENDICHTRING / OIL-SEAL*
60/75/8 A FPM WELLENDICHTRING / OIL-SEAL*
60/75/8 AS FPM WELLENDICHTRING / OIL-SEAL*
60/75/8/9 AS-P FPM WELLENDICHTRING / OIL-SEAL
60/75/10 A FPM WELLENDICHTRING / OIL-SEAL*
60/75/10/10,5 AS-P FPM WELLENDICHTRING / OIL-SEAL*
60/78/10 A FPM WELLENDICHTRING / OIL-SEAL*
60/80/7/7,5 AS-P FPM WELLENDICHTRING / OIL-SEAL*
60/80/8 A FPM WELLENDICHTRING / OIL-SEAL*
60/80/8 AS FPM WELLENDICHTRING / OIL-SEAL*
60/80/10 A FPM WELLENDICHTRING / OIL-SEAL*
60/80/10 AS FPM WELLENDICHTRING / OIL-SEAL*
60/80/12 A FPM WELLENDICHTRING / OIL-SEAL*
60/80/12 AS FPM WELLENDICHTRING / OIL-SEAL*
60/85/8 A FPM WELLENDICHTRING / OIL-SEAL*
60/85/8 AS FPM WELLENDICHTRING / OIL-SEAL*
60/85/10 A FPM WELLENDICHTRING / OIL-SEAL*
60/85/10 AS FPM WELLENDICHTRING / OIL-SEAL*

60/90/8 A FPM WELLENDICHTRING / OIL-SEAL*
60/90/10 A FPM WELLENDICHTRING / OIL-SEAL*
60/90/10 AS FPM WELLENDICHTRING / OIL-SEAL*
60/90/13 A FPM WELLENDICHTRING / OIL-SEAL*
60/95/10 A FPM WELLENDICHTRING / OIL-SEAL*
60/95/10 AS FPM WELLENDICHTRING / OIL-SEAL
60/100/10 AS FPM WELLENDICHTRING / OIL-SEAL
60/110/13 A FPM WELLENDICHTRING / OIL-SEAL*
62/80/10 A FPM WELLENDICHTRING / OIL-SEAL*
62/80/10 AS FPM WELLENDICHTRING / OIL-SEAL
62/85/7 AS-P FPM WELLENDICHTRING / OIL-SEAL
62/85/10 A FPM WELLENDICHTRING / OIL-SEAL*
62/85/10 AS FPM WELLENDICHTRING / OIL-SEAL
62/85/12 A FPM WELLENDICHTRING / OIL-SEAL
62/90/10 A FPM WELLENDICHTRING / OIL-SEAL
62/90/10 AS FPM WELLENDICHTRING / OIL-SEAL
63,5/73,03/6,35 A FPM WELLENDICHTRING / OIL-SEAL
63/85/10 A FPM WELLENDICHTRING / OIL-SEAL*
63/85/10 AS FPM WELLENDICHTRING / OIL-SEAL
63,5/88,9/11,11 A FPM WELLENDICHTRING / OIL-SEAL
64/80/8 AS FPM WELLENDICHTRING / OIL-SEAL
65/80/8 A FPM WELLENDICHTRING / OIL-SEAL*
65/80/8 AS FPM WELLENDICHTRING / OIL-SEAL*
65/80/10 AS FPM WELLENDICHTRING / OIL-SEAL*
65/85/8 A FPM WELLENDICHTRING / OIL-SEAL*
65/85/8 AS-P FPM WELLENDICHTRING / OIL-SEAL
65/85/10 A FPM WELLENDICHTRING / OIL-SEAL*
65/85/10 AS FPM WELLENDICHTRING / OIL-SEAL*
65/85/13 AS FPM WELLENDICHTRING / OIL-SEAL*
65/88/12 AS FPM WELLENDICHTRING / OIL-SEAL
65/90/7 AS FPM WELLENDICHTRING / OIL-SEAL
65/90/10 AS FPM WELLENDICHTRING / OIL-SEAL*
65/95/10 A FPM WELLENDICHTRING / OIL-SEAL*
65/95/10 AS FPM WELLENDICHTRING / OIL-SEAL
65/100/10 A FPM WELLENDICHTRING / OIL-SEAL*
65/100/10 AS FPM WELLENDICHTRING / OIL-SEAL
65/110/10 AS FPM WELLENDICHTRING / OIL-SEAL
66,68/85,73/9,53 A FPM WELLENDICHTRING / OIL-SEAL
68/90/10 A FPM WELLENDICHTRING / OIL-SEAL*
68/90/10 AS FPM WELLENDICHTRING / OIL-SEAL*
68/100/10 A FPM WELLENDICHTRING / OIL-SEAL
70/85/7 A FPM WELLENDICHTRING / OIL-SEAL*
70/85/8 A FPM WELLENDICHTRING / OIL-SEAL*
70/85/8 AS FPM WELLENDICHTRING / OIL-SEAL
70/85/10 AS FPM WELLENDICHTRING / OIL-SEAL
70/88/9 A FPM WELLENDICHTRING / OIL-SEAL
70/90/7 AS-P FPM WELLENDICHTRING / OIL-SEAL*
70/90/10 A FPM WELLENDICHTRING / OIL-SEAL*
70/90/10 AS FPM WELLENDICHTRING / OIL-SEAL*
70/90/10 AS-P FPM WELLENDICHTRING / OIL-SEAL

70/90/12 A FPM WELLENDICHTRING / OIL-SEAL*
70/90/13 A FPM WELLENDICHTRING / OIL-SEAL*
70/90/13 AS FPM WELLENDICHTRING / OIL-SEAL*
70/95/10 A FPM WELLENDICHTRING / OIL-SEAL*
70/100/10 A FPM WELLENDICHTRING / OIL-SEAL*
70/100/10 AS FPM WELLENDICHTRING / OIL-SEAL*
70/100/12 A FPM WELLENDICHTRING / OIL-SEAL*
70/100/12 AS FPM WELLENDICHTRING / OIL-SEAL*
70/110/10 A FPM WELLENDICHTRING / OIL-SEAL*
70/110/10 AS FPM WELLENDICHTRING / OIL-SEAL*
70/110/12 AS FPM WELLENDICHTRING / OIL-SEAL*
70/110/13 AS FPM WELLENDICHTRING / OIL-SEAL*
70/120/12 AS FPM WELLENDICHTRING / OIL-SEAL*
70/120/13 A FPM WELLENDICHTRING / OIL-SEAL*
72/90/10 A FPM WELLENDICHTRING / OIL-SEAL*
72/95/10 A FPM WELLENDICHTRING / OIL-SEAL*
72/100/10 AS FPM WELLENDICHTRING / OIL-SEAL*
72/100/13 AS FPM WELLENDICHTRING / OIL-SEAL*
75/90/8 A FPM WELLENDICHTRING / OIL-SEAL*
75/90/8 AS FPM WELLENDICHTRING / OIL-SEAL*
75/90/10 A FPM WELLENDICHTRING / OIL-SEAL*
75/90/10 AS FPM WELLENDICHTRING / OIL-SEAL*
75/95/10 A FPM WELLENDICHTRING / OIL-SEAL*
75/95/10 AS FPM WELLENDICHTRING / OIL-SEAL*
75/95/12 A FPM WELLENDICHTRING / OIL-SEAL*
75/100/10 A FPM WELLENDICHTRING / OIL-SEAL*
75/100/10 AS FPM WELLENDICHTRING / OIL-SEAL*
75/100/12 A FPM WELLENDICHTRING / OIL-SEAL*
75/100/13 AS FPM WELLENDICHTRING / OIL-SEAL*
75/110/12 A FPM WELLENDICHTRING / OIL-SEAL*
75/110/13 A FPM WELLENDICHTRING / OIL-SEAL*
75/110/13 AS FPM WELLENDICHTRING / OIL-SEAL*
75/115/13 AS FPM WELLENDICHTRING / OIL-SEAL*
77,78/114,3/12,7 A FPM WELLENDICHTRING / OIL-SEAL*
78/100/10 A FPM WELLENDICHTRING / OIL-SEAL*
78/100/10 AS FPM WELLENDICHTRING / OIL-SEAL*
78/110/12 A FPM WELLENDICHTRING / OIL-SEAL*
80/95/8 A FPM WELLENDICHTRING / OIL-SEAL*
80/100/7 A FPM WELLENDICHTRING / OIL-SEAL*
80/100/7/7,5 AS-P FPM WELLENDICHTRING / OIL-SEAL*
80/100/10 A FPM WELLENDICHTRING / OIL-SEAL*
80/100/10 AS FPM WELLENDICHTRING / OIL-SEAL*
80/100/12 AS FPM WELLENDICHTRING / OIL-SEAL*
80/100/13 AS FPM WELLENDICHTRING / OIL-SEAL*
80/105/10 A FPM WELLENDICHTRING / OIL-SEAL*
80/105/10 AS FPM WELLENDICHTRING / OIL-SEAL*
80/105/12 A FPM WELLENDICHTRING / OIL-SEAL*
80/105/13 AS FPM WELLENDICHTRING / OIL-SEAL*
80/110/10 A FPM WELLENDICHTRING / OIL-SEAL*
80/110/10 AS FPM WELLENDICHTRING / OIL-SEAL*

80/110/12 A FPM WELLENDICHTRING / OIL-SEAL*
80/110/12 AS FPM WELLENDICHTRING / OIL-SEAL
80/125/12 AS FPM WELLENDICHTRING / OIL-SEAL*
80/125/13 AS FPM WELLENDICHTRING / OIL-SEAL
82/105/12 A FPM WELLENDICHTRING / OIL-SEAL*
82/105/12 AS FPM WELLENDICHTRING / OIL-SEAL
85/100/10 AS FPM WELLENDICHTRING / OIL-SEAL
85/100/12 AS FPM WELLENDICHTRING / OIL-SEAL
85/105/7/7,5 AS-P FPM WELLENDICHTRING / OIL-SEAL
85/105/10 AS FPM WELLENDICHTRING / OIL-SEAL
85/105/12 AS FPM WELLENDICHTRING / OIL-SEAL
85/105/13 A FPM WELLENDICHTRING / OIL-SEAL*
85/110/12 A FPM WELLENDICHTRING / OIL-SEAL*
85/110/12 AS FPM WELLENDICHTRING / OIL-SEAL*
85/110/13 AS FPM WELLENDICHTRING / OIL-SEAL
85/115/13 AS FPM WELLENDICHTRING / OIL-SEAL
85/120/12 A FPM WELLENDICHTRING / OIL-SEAL*
85/120/12 AS FPM WELLENDICHTRING / OIL-SEAL*
85/125/12 AS FPM WELLENDICHTRING / OIL-SEAL
85/130/12 AS FPM WELLENDICHTRING / OIL-SEAL
85/130/13 AS FPM WELLENDICHTRING / OIL-SEAL*
90/110/7,5 AS-P FPM WELLENDICHTRING / OIL-SEAL*
90/110/8 AS FPM WELLENDICHTRING / OIL-SEAL
90/110/10 A FPM WELLENDICHTRING / OIL-SEAL
90/110/12 A FPM WELLENDICHTRING / OIL-SEAL*
90/110/12 AS FPM WELLENDICHTRING / OIL-SEAL*
90/110/12 AS-P FPM WELLENDICHTRING / OIL-SEAL*
90/110/13 AS FPM WELLENDICHTRING / OIL-SEAL*
90/110/13 AS-PX FPM WELLENDICHTRING / OIL-SEAL
90/115/9 A FPM WELLENDICHTRING / OIL-SEAL*
90/115/12 A FPM WELLENDICHTRING / OIL-SEAL*
90/120/10 AS FPM WELLENDICHTRING / OIL-SEAL
90/120/12 A FPM WELLENDICHTRING / OIL-SEAL*
90/120/12 AS FPM WELLENDICHTRING / OIL-SEAL*
90/120/13 A FPM WELLENDICHTRING / OIL-SEAL*
92/120/13 A FPM WELLENDICHTRING / OIL-SEAL*
95/110/10 A FPM WELLENDICHTRING / OIL-SEAL*
95/110/10 AS FPM WELLENDICHTRING / OIL-SEAL
95/115/13 AS FPM WELLENDICHTRING / OIL-SEAL*
95/120/12 A FPM WELLENDICHTRING / OIL-SEAL*
95/120/12 AS FPM WELLENDICHTRING / OIL-SEAL*
95/120/13 AS FPM WELLENDICHTRING / OIL-SEAL*
95/125/12 A FPM WELLENDICHTRING / OIL-SEAL*
95/125/12 AS FPM WELLENDICHTRING / OIL-SEAL*
95/130/13 AS FPM WELLENDICHTRING / OIL-SEAL
96/117/10 A FPM WELLENDICHTRING / OIL-SEAL
100/115/9 AS FPM WELLENDICHTRING / OIL-SEAL*
100/120/7 AS FPM WELLENDICHTRING / OIL-SEAL
100/120/12 A FPM WELLENDICHTRING / OIL-SEAL*
100/120/12 AS FPM WELLENDICHTRING / OIL-SEAL*

100/120/13 A FPM WELLENDICHTRING / OIL-SEAL*
100/125/12 AS FPM WELLENDICHTRING / OIL-SEAL
100/125/13 A FPM WELLENDICHTRING / OIL-SEAL*
100/125/13 AS FPM WELLENDICHTRING / OIL-SEAL
100/130/12 A FPM WELLENDICHTRING / OIL-SEAL*
100/130/12 AS FPM WELLENDICHTRING / OIL-SEAL*
100/130/12/13 AS-P FPM WELLENDICHTRING / OIL-SEAL
100/130/13 AS FPM WELLENDICHTRING / OIL-SEAL
100/140/12 AS FPM WELLENDICHTRING / OIL-SEAL
100/140/13 AS FPM WELLENDICHTRING / OIL-SEAL
100/150/13 AS FPM WELLENDICHTRING / OIL-SEAL
105/125/13 A FPM WELLENDICHTRING / OIL-SEAL*
105/125/13 AS FPM WELLENDICHTRING / OIL-SEAL*
105/130/7,5 AS-P FPM WELLENDICHTRING / OIL-SEAL
105/130/12 A FPM WELLENDICHTRING / OIL-SEAL*
105/130/12 AS FPM WELLENDICHTRING / OIL-SEAL*
105/130/13 AS FPM WELLENDICHTRING / OIL-SEAL*
105/135/12 A FPM WELLENDICHTRING / OIL-SEAL
105/140/12 A FPM WELLENDICHTRING / OIL-SEAL*
105/140/12 AS FPM WELLENDICHTRING / OIL-SEAL
105/160/12 AS FPM WELLENDICHTRING / OIL-SEAL
110/130/8 A FPM WELLENDICHTRING / OIL-SEAL*
110/130/12 A FPM WELLENDICHTRING / OIL-SEAL*
110/130/12 AS FPM WELLENDICHTRING / OIL-SEAL*
110/130/13 A FPM WELLENDICHTRING / OIL-SEAL*
110/135/12 A FPM WELLENDICHTRING / OIL-SEAL
110/140/12 A FPM WELLENDICHTRING / OIL-SEAL*
110/140/12 AS FPM WELLENDICHTRING / OIL-SEAL*
110/140/13 A FPM WELLENDICHTRING / OIL-SEAL*
110/140/15 AS FPM WELLENDICHTRING / OIL-SEAL
110/150/12 AS FPM WELLENDICHTRING / OIL-SEAL
110/150/13 AS FPM WELLENDICHTRING / OIL-SEAL
110/150/15 AS FPM WELLENDICHTRING / OIL-SEAL
115/130/12 A FPM WELLENDICHTRING / OIL-SEAL*
115/140/10 A FPM WELLENDICHTRING / OIL-SEAL
115/140/12 A FPM WELLENDICHTRING / OIL-SEAL*
115/140/12 AS FPM WELLENDICHTRING / OIL-SEAL*
115/150/12 A FPM WELLENDICHTRING / OIL-SEAL*
120/140/10 A FPM WELLENDICHTRING / OIL-SEAL*
120/140/13 A FPM WELLENDICHTRING / OIL-SEAL*
120/140/13 AS FPM WELLENDICHTRING / OIL-SEAL
120/140/13/14 AS-P FPM WELLENDICHTRING / OIL-SEAL
120/140/7,5/8,5 AS-P FPM WELLENDICHTRING / OIL-SEAL
120/150/12 A FPM WELLENDICHTRING / OIL-SEAL*
120/150/12 AS-P FPM WELLENDICHTRING / OIL-SEAL
120/150/13 A FPM WELLENDICHTRING / OIL-SEAL*
120/150/15 AS FPM WELLENDICHTRING / OIL-SEAL*
120/160/12 A FPM WELLENDICHTRING / OIL-SEAL*
120/160/12 AS FPM WELLENDICHTRING / OIL-SEAL
120/160/15 A FPM WELLENDICHTRING / OIL-SEAL*

120/160/15 AS FPM WELLENDICHTRING / OIL-SEAL
125/150/12 A FPM WELLENDICHTRING / OIL-SEAL*
125/150/12 AS FPM WELLENDICHTRING / OIL-SEAL*
125/150/15 AS FPM WELLENDICHTRING / OIL-SEAL
125/155/12 A FPM WELLENDICHTRING / OIL-SEAL*
125/160/12 A FPM WELLENDICHTRING / OIL-SEAL*
125/160/12 AS FPM WELLENDICHTRING / OIL-SEAL
128/158/20 A FPM WELLENDICHTRING / OIL-SEAL
130/150/7/7,5 AS-P FPM WELLENDICHTRING / OIL-SEAL
130/150/10 AS FPM WELLENDICHTRING / OIL-SEAL
130/150/12 AS FPM WELLENDICHTRING / OIL-SEAL*
130/160/12 A FPM WELLENDICHTRING / OIL-SEAL*
130/160/12 AS FPM WELLENDICHTRING / OIL-SEAL*
130/160/12 AS-P FPM WELLENDICHTRING / OIL-SEAL
130/160/13 A FPM WELLENDICHTRING / OIL-SEAL*
130/160/15 A FPM WELLENDICHTRING / OIL-SEAL*
130/160/15 AS FPM WELLENDICHTRING / OIL-SEAL*
130/160/15 AS FPM WELLENDICHTRING / OIL-SEAL*
130/170/12 A FPM WELLENDICHTRING / OIL-SEAL*
130/170/12 AS FPM WELLENDICHTRING / OIL-SEAL
135/160/12 A FPM WELLENDICHTRING / OIL-SEAL*
135/160/12 AS FPM WELLENDICHTRING / OIL-SEAL
135/160/15 AS FPM WELLENDICHTRING / OIL-SEAL
135/165/12 A FPM WELLENDICHTRING / OIL-SEAL
135/170/12 A FPM WELLENDICHTRING / OIL-SEAL*
140/160/13 AS FPM WELLENDICHTRING / OIL-SEAL*
140/165/12 A FPM WELLENDICHTRING / OIL-SEAL*
140/170/12 A FPM WELLENDICHTRING / OIL-SEAL*
140/170/12 AS FPM WELLENDICHTRING / OIL-SEAL*
140/170/15 A FPM WELLENDICHTRING / OIL-SEAL*
140/170/15 AS FPM WELLENDICHTRING / OIL-SEAL*
140/180/12 A FPM WELLENDICHTRING / OIL-SEAL*
140/180/12 AS FPM WELLENDICHTRING / OIL-SEAL*
140/180/15 A FPM WELLENDICHTRING / OIL-SEAL*
140/180/15 AS FPM WELLENDICHTRING / OIL-SEAL
140/180/16 AX-7M FPM WELLENDICHTRING / OIL-SEAL-
145/170/15 AS FPM WELLENDICHTRING / OIL-SEAL*
145/175/13 AS FPM WELLENDICHTRING / OIL-SEAL
145/175/15 A FPM WELLENDICHTRING / OIL-SEAL*
145/175/15 AS FPM WELLENDICHTRING / OIL-SEAL*
145/180/12 A FPM WELLENDICHTRING / OIL-SEAL*
145/180/13 A FPM WELLENDICHTRING / OIL-SEAL*
145/180/14 A FPM WELLENDICHTRING / OIL-SEAL*
145/184/15 AS FPM WELLENDICHTRING / OIL-SEAL
148/170/15 AS FPM WELLENDICHTRING / OIL-SEAL
150/170/12 A FPM WELLENDICHTRING / OIL-SEAL*
150/170/15 AS FPM WELLENDICHTRING / OIL-SEAL
150/180/12 A FPM WELLENDICHTRING / OIL-SEAL*
150/180/13 A FPM WELLENDICHTRING / OIL-SEAL*
150/180/13 AS FPM WELLENDICHTRING / OIL-SEAL*

150/180/15 A FPM WELLENDICHTRING / OIL-SEAL*
150/180/15 AS FPM WELLENDICHTRING / OIL-SEAL
150/190/15 AS FPM WELLENDICHTRING / OIL-SEAL
150/200/15 AS FPM WELLENDICHTRING / OIL-SEAL
155/180/15 AS FPM WELLENDICHTRING / OIL-SEAL
155/190/15 AS FPM WELLENDICHTRING / OIL-SEAL
160/180/10 AS FPM WELLENDICHTRING / OIL-SEAL
160/180/15 AS FPM WELLENDICHTRING / OIL-SEAL
160/185/10 A FPM WELLENDICHTRING / OIL-SEAL*
160/185/8,5/9,5 AS-P FPM WELLENDICHTRING / OIL-SEAL
160/190/13 A FPM WELLENDICHTRING / OIL-SEAL*
160/190/15 A FPM WELLENDICHTRING / OIL-SEAL*
160/190/15 AS FPM WELLENDICHTRING / OIL-SEAL*
160/200/12 A FPM WELLENDICHTRING / OIL-SEAL
160/200/12 AS FPM WELLENDICHTRING / OIL-SEAL
164,5/190/13 A FPM WELLENDICHTRING / OIL-SEAL
165/190/13 A FPM WELLENDICHTRING / OIL-SEAL*
165/190/13 AS FPM WELLENDICHTRING / OIL-SEAL
165/190/15 AS FPM WELLENDICHTRING / OIL-SEAL
165/195/15 A FPM WELLENDICHTRING / OIL-SEAL
165/200/15 A FPM WELLENDICHTRING / OIL-SEAL
170/190/15 A FPM WELLENDICHTRING / OIL-SEAL*
170/200/12 A FPM WELLENDICHTRING / OIL-SEAL*
170/200/12 AS FPM WELLENDICHTRING / OIL-SEAL
170/200/13 A FPM WELLENDICHTRING / OIL-SEAL
170/200/15 A FPM WELLENDICHTRING / OIL-SEAL*
170/200/15 AS FPM WELLENDICHTRING / OIL-SEAL*
175/200/10 A FPM WELLENDICHTRING / OIL-SEAL
175/200/12 AS FPM WELLENDICHTRING / OIL-SEAL
175/200/15 A FPM WELLENDICHTRING / OIL-SEAL*
175/200/15 AS FPM WELLENDICHTRING / OIL-SEAL*
175/205/15 AS FPM WELLENDICHTRING / OIL-SEAL
180/200/13 A FPM WELLENDICHTRING / OIL-SEAL*
180/200/16 AS FPM WELLENDICHTRING / OIL-SEAL
180/210/15 A FPM WELLENDICHTRING / OIL-SEAL*
180/210/15 AS FPM WELLENDICHTRING / OIL-SEAL*
180/210/8,5/9,5 AS-P FPM WELLENDICHTRING / OIL-SEAL
180/215/16 A FPM WELLENDICHTRING / OIL-SEAL*
180/220/15 A FPM WELLENDICHTRING / OIL-SEAL*
180/220/15 AS FPM WELLENDICHTRING / OIL-SEAL
184,15/222,25/14,2 A FPM WELLENDICHTRING / OIL-SEAL
185/205/10 AS FPM WELLENDICHTRING / OIL-SEAL
185/210/10 A FPM WELLENDICHTRING / OIL-SEAL
185/210/13 A FPM WELLENDICHTRING / OIL-SEAL*
185/215/16 A FPM WELLENDICHTRING / OIL-SEAL
190/215/15 AS FPM WELLENDICHTRING / OIL-SEAL
190/215/16 AS FPM WELLENDICHTRING / OIL-SEAL*
190/220/15 A FPM WELLENDICHTRING / OIL-SEAL*
190/220/15 AS FPM WELLENDICHTRING / OIL-SEAL
190/225/16 AS FPM WELLENDICHTRING / OIL-SEAL*

190/230/15 AS FPM WELLENDICHTRING / OIL-SEAL
190/230/16 AS FPM WELLENDICHTRING / OIL-SEAL
195/230/16 AS FPM WELLENDICHTRING / OIL-SEAL
200/225/15 A FPM WELLENDICHTRING / OIL-SEAL
200/230/13 A FPM WELLENDICHTRING / OIL-SEAL*
200/230/15 A FPM WELLENDICHTRING / OIL-SEAL*
200/230/15 AS FPM WELLENDICHTRING / OIL-SEAL*
200/240/20 AS FPM WELLENDICHTRING / OIL-SEAL
200/250/15 A FPM WELLENDICHTRING / OIL-SEAL*
205/230/16 A FPM WELLENDICHTRING / OIL-SEAL*
210/240/15 A FPM WELLENDICHTRING / OIL-SEAL*
210/240/15 AS FPM WELLENDICHTRING / OIL-SEAL
210/250/15 A FPM WELLENDICHTRING / OIL-SEAL*
215/250/16 A FPM WELLENDICHTRING / OIL-SEAL
220/250/12 A FPM WELLENDICHTRING / OIL-SEAL
220/250/15 A FPM WELLENDICHTRING / OIL-SEAL*
220/250/15 AS FPM WELLENDICHTRING / OIL-SEAL*
220/250/16 AS FPM WELLENDICHTRING / OIL-SEAL
220/260/16 A FPM WELLENDICHTRING / OIL-SEAL*
230/260/15 A FPM WELLENDICHTRING / OIL-SEAL*
230/260/15 AS FPM WELLENDICHTRING / OIL-SEAL*
230/270/15 AS FPM WELLENDICHTRING / OIL-SEAL
230/280/15 A FPM WELLENDICHTRING / OIL-SEAL
230/280/15 A FPM WELLENDICHTRING / OIL-SEAL
240/270/15 A FPM WELLENDICHTRING / OIL-SEAL*
240/270/15 AS FPM WELLENDICHTRING / OIL-SEAL*
240/280/15 A FPM WELLENDICHTRING / OIL-SEAL*
250/280/15 A FPM WELLENDICHTRING / OIL-SEAL*
250/280/15 AS FPM WELLENDICHTRING / OIL-SEAL
250/280/15/17 AS-P FPM WELLENDICHTRING / OIL-SEAL
250/290/16 AS FPM WELLENDICHTRING / OIL-SEAL
259/300/20 A-DUO FPM WELLENDICHTRING / OIL-SEAL
260/290/15 A FPM WELLENDICHTRING / OIL-SEAL
260/290/16 AS FPM WELLENDICHTRING / OIL-SEAL
260/300/20 A FPM WELLENDICHTRING / OIL-SEAL*
260/300/20 AS FPM WELLENDICHTRING / OIL-SEAL*
265/290/16 A FPM WELLENDICHTRING / OIL-SEAL*
265/290/16 AS FPM WELLENDICHTRING / OIL-SEAL
280/310/15 A FPM WELLENDICHTRING / OIL-SEAL*
280/310/15 AS FPM WELLENDICHTRING / OIL-SEAL
280/320/15 AS FPM WELLENDICHTRING / OIL-SEAL
280/320/20 A FPM WELLENDICHTRING / OIL-SEAL*
280/320/20 AS FPM WELLENDICHTRING / OIL-SEAL*
300/340/16 AS FPM WELLENDICHTRING / OIL-SEAL*
300/340/18 A FPM WELLENDICHTRING / OIL-SEAL*
300/340/20 A FPM WELLENDICHTRING / OIL-SEAL*
300/340/20 AS FPM WELLENDICHTRING / OIL-SEAL*
310/350/18 AS FPM WELLENDICHTRING / OIL-SEAL
320/360/18 AS FPM WELLENDICHTRING / OIL-SEAL
320/360/20 A FPM WELLENDICHTRING / OIL-SEAL*

320/360/20 AS FPM WELLENDICHTRING / OIL-SEAL
330/370/18 A FPM WELLENDICHTRING / OIL-SEAL*
340/380/18 A FPM WELLENDICHTRING / OIL-SEAL*
340/380/20 A FPM WELLENDICHTRING / OIL-SEAL*
340/380/20 AS FPM WELLENDICHTRING / OIL-SEAL*
350/380/15 AS FPM WELLENDICHTRING / OIL-SEAL
350/390/18 A FPM WELLENDICHTRING / OIL-SEAL*
360/400/20 AS FPM WELLENDICHTRING / OIL-SEAL*
370/410/15 A FPM WELLENDICHTRING / OIL-SEAL*
380/420/20 A FPM WELLENDICHTRING / OIL-SEAL*
380/420/20 AS FPM WELLENDICHTRING / OIL-SEAL*
394/420/16 A FPM WELLENDICHTRING / OIL-SEAL
400/440/20 A FPM WELLENDICHTRING / OIL-SEAL*
400/440/20 AS FPM WELLENDICHTRING / OIL-SEAL
420/460/15 AS-P FPM WELLENDICHTRING / OIL-SEAL
420/460/20 A FPM WELLENDICHTRING / OIL-SEAL*
420/460/20 A FPM WELLENDICHTRING / OIL-SEAL
420/460/20 AS FPM WELLENDICHTRING / OIL-SEAL
420/470/20 AS FPM WELLENDICHTRING / OIL-SEAL
440/480/20 A FPM WELLENDICHTRING / OIL-SEAL*
440/480/20 AS FPM WELLENDICHTRING / OIL-SEAL*
450/494/20 A FPM WELLENDICHTRING / OIL-SEAL
450/500/20 A FPM WELLENDICHTRING / OIL-SEAL
450/500/22 A FPM WELLENDICHTRING / OIL-SEAL
460/500/20 AS FPM WELLENDICHTRING / OIL-SEAL
480/520/20 A FPM WELLENDICHTRING / OIL-SEAL*
480/520/20 AS FPM WELLENDICHTRING / OIL-SEAL
500/540/20 A FPM WELLENDICHTRING / OIL-SEAL*
500/540/20 AS FPM WELLENDICHTRING / OIL-SEAL*
550/600/25 A FPM WELLENDICHTRING / OIL-SEAL
560/610/20 A FPM WELLENDICHTRING / OIL-SEAL
600/640/20 A FPM WELLENDICHTRING / OIL-SEAL
670/730/25 A FPM WELLENDICHTRING / OIL-SEAL
760/800/20 A FPM WELLENDICHTRING / OIL-SEAL
349,25/393,7/19,05 C59D NBR WELLENDICHTRING / OIL-SEAL
20/35/7 B NBR WELLENDICHTRING / OIL-SEAL
25/35/7 B NBR WELLENDICHTRING / OIL-SEAL
32/52/7 BS NBR WELLENDICHTRING / OIL-SEAL
35/52/7 B NBR WELLENDICHTRING / OIL-SEAL
36/52/7 BS NBR WELLENDICHTRING / OIL-SEAL,
42/55/8 B NBR WELLENDICHTRING / OIL-SEAL
45/62/9 BS NBR WELLENDICHTRING / OIL-SEAL
47/72/12 B NBR WELLENDICHTRING / OIL-SEAL
48/62/8 B NBR WELLENDICHTRING / OIL-SEAL
50/62/7 B NBR WELLENDICHTRING / OIL-SEAL
50/72/8 B NBR WELLENDICHTRING / OIL-SEAL
50/90/10 BS NBR WELLENDICHTRING / OIL-SEAL
60/80/12 BS NBR WELLENDICHTRING / OIL-SEAL
65/85/10 B NBR WELLENDICHTRING / OIL-SEAL
88/105/12 B NBR WELLENDICHTRING / OIL-SEAL,

88/110/10 B NBR WELLENDICHTRING / OIL-SEAL
88/110/13 B NBR WELLENDICHTRING / OIL-SEAL
88/110/13 BS NBR WELLENDICHTRING / OIL-SEAL
90/120/15 B NBR WELLENDICHTRING / OIL-SEAL,
100/120/8 B NBR WELLENDICHTRING / OIL-SEAL
160/185/10 B NBR WELLENDICHTRING / OIL-SEAL
192/210/10 B NBR WELLENDICHTRING / OIL-SEAL
215/250/16 B NBR WELLENDICHTRING / OIL-SEAL
260/300/20 B NBR WELLENDICHTRING / OIL-SEAL
270/310/16 BS NBR WELLENDICHTRING / OIL-SEAL
350/380/16 B NBR WELLENDICHTRING / OIL-SEAL
400/440/20 BS NBR WELLENDICHTRING / OIL-SEAL
460/500/20 B NBR WELLENDICHTRING / OIL-SEAL
510/550/20 B NBR WELLENDICHTRING / OIL-SEAL
580/630/22 BS NBR WELLENDICHTRING / OIL-SEAL
13/23/6,5 B FPM WELLENDICHTRING / OIL-SEAL
16/25/4 B-O FPM WELLENDICHTRING / OIL-SEAL
20/30/7 B FPM WELLENDICHTRING / OIL-SEAL
54/70/12 B FPM WELLENDICHTRING / OIL-SEAL
60/80/10 BS FPM WELLENDICHTRING / OIL-SEAL
80/100/10 BS FPM WELLENDICHTRING / OIL-SEAL
90/115/13 B FPM WELLENDICHTRING / OIL-SEAL
110/140/12 B FPM WELLENDICHTRING / OIL-SEAL
132/145/5 BS-P FPM WELLENDICHTRING / OIL-SEAL
155/190/15 B FPM WELLENDICHTRING / OIL-SEAL
175/205/15 B FPM WELLENDICHTRING / OIL-SEAL
400/440/20 B FPM WELLENDICHTRING / OIL-SEAL
430/480/25 BS FPM WELLENDICHTRING / OIL-SEAL
460/500/20 B FPM WELLENDICHTRING / OIL-SEAL
630/670/20 BS FPM WELLENDICHTRING / OIL-SEAL
30/56/12 C NBR WELLENDICHTRING / OIL-SEAL
32/52/10 C NBR WELLENDICHTRING / OIL-SEAL
45/60/10 C NBR WELLENDICHTRING / OIL-SEAL
50/80/10 C NBR WELLENDICHTRING / OIL-SEAL
55/80/13 C NBR WELLENDICHTRING / OIL-SEAL
58/75/12 C NBR WELLENDICHTRING / OIL-SEAL
65/85/12 C NBR WELLENDICHTRING / OIL-SEAL
65/90/12 C NBR WELLENDICHTRING / OIL-SEAL
70/100/10 C NBR WELLENDICHTRING / OIL-SEAL
75/105/12 CS NBR WELLENDICHTRING / OIL-SEAL
80/100/10 C NBR WELLENDICHTRING / OIL-SEAL
80/100/13 C NBR WELLENDICHTRING / OIL-SEAL
85/110/15 C NBR WELLENDICHTRING / OIL-SEAL
90/110/8 C NBR WELLENDICHTRING / OIL-SEAL
90/110/13 C NBR WELLENDICHTRING / OIL-SEAL
95/115/13 C NBR WELLENDICHTRING / OIL-SEAL
95/125/13 C NBR WELLENDICHTRING / OIL-SEAL
95/128/13 CS NBR WELLENDICHTRING / OIL-SEAL
101,6/127/12,7 C NBR WELLENDICHTRING / OIL-SEAL
105/130/13 C NBR WELLENDICHTRING / OIL-SEAL

107,95/133,35/12,7 C NBR WELLENDICHTRING / OIL-SEAL
108/130/13 C NBR WELLENDICHTRING / OIL-SEAL
110/140/12 C NBR WELLENDICHTRING / OIL-SEAL,
110/140/15 C NBR WELLENDICHTRING / OIL-SEAL
110/150/13 C NBR WELLENDICHTRING / OIL-SEAL
114,3/139,7/12,7 C NBR WELLENDICHTRING / OIL-SEAL
120/140/13 C NBR WELLENDICHTRING / OIL-SEAL
120/140/13 CS NBR WELLENDICHTRING / OIL-SEAL
120,65/146,05/12,7 C NBR WELLENDICHTRING / OIL-SEAL
120/150/15 C NBR WELLENDICHTRING / OIL-SEAL
120/170/15 C NBR WELLENDICHTRING / OIL-SEAL
127/165,1/12,7 CS NBR WELLENDICHTRING / OIL-SEAL
131,78/158,75/12,7 C NBR WELLENDICHTRING / OIL-SEAL
139,7/165,1/12,7 C NBR WELLENDICHTRING / OIL-SEAL
140/180/15 C NBR WELLENDICHTRING / OIL-SEAL
145/165/13 C NBR WELLENDICHTRING / OIL-SEAL,
145/175/13 C NBR WELLENDICHTRING / OIL-SEAL,
150/180/15 C NBR WELLENDICHTRING / OIL-SEAL
150/200/15 C NBR WELLENDICHTRING / OIL-SEAL
160/190/15 C NBR WELLENDICHTRING / OIL-SEAL
170/200/15 C NBR WELLENDICHTRING / OIL-SEAL
180/210/15 C NBR WELLENDICHTRING / OIL-SEAL
190/220/15 C NBR WELLENDICHTRING / OIL-SEAL
195/230/15 C NBR WELLENDICHTRING / OIL-SEAL
200/230/15 C NBR WELLENDICHTRING / OIL-SEAL
203,2/254/15,87 CS NBR WELLENDICHTRING / OIL-SEAL
205/250/16 C NBR OSFB WELLENDICHTRING / OIL-SEAL
210/240/15 C NBR WELLENDICHTRING / OIL-SEAL
218/250/16 C NBR WELLENDICHTRING / OIL-SEAL,
220/250/15 C NBR WELLENDICHTRING / OIL-SEAL
230/270/15 C NBR WELLENDICHTRING / OIL-SEAL
240/270/15 C NBR WELLENDICHTRING / OIL-SEAL
250/280/15 C NBR WELLENDICHTRING / OIL-SEAL
260/290/16 C NBR WELLENDICHTRING / OIL-SEAL
260/310/16 C NBR WELLENDICHTRING / OIL-SEAL
265/310/16 C NBR OSFB WELLENDICHTRING / OIL-SEAL
270/310/16 C NBR WELLENDICHTRING / OIL-SEAL
280/310/16 C NBR OSFB WELLENDICHTRING / OIL-SEAL
280/320/20 C NBR WELLENDICHTRING / OIL-SEAL
290/330/18 C NBR WELLENDICHTRING / OIL-SEAL
290/330/18 C NBR WELLENDICHTRING / OIL-SEAL
298,45/336,55/17,4 C NBR WELLENDICHTRING / OIL-SEAL
300/332/16 C NBR WELLENDICHTRING / OIL-SEAL
300/335/18 C NBR WELLENDICHTRING / OIL-SEAL
300/340/20 C NBR WELLENDICHTRING / OIL-SEAL *
320/360/18 C NBR WELLENDICHTRING / OIL-SEAL
320/360/20 C NBR WELLENDICHTRING / OIL-SEAL
330/370/18 C NBR WELLENDICHTRING / OIL-SEAL
340/372/16 C NBR WELLENDICHTRING / OIL-SEAL
360/390/18 C NBR WELLENDICHTRING / OIL-SEAL

380/420/20 C NBR WELLENDICHTRING / OIL-SEAL
400/440/20 C NBR WELLENDICHTRING / OIL-SEAL
460/500/20 C NBR WELLENDICHTRING / OIL-SEAL
467/510/20 CS NBR WELLENDICHTRING / OIL-SEAL
480/520/20 C NBR WELLENDICHTRING / OIL-SEAL
560/600/20 C NBR WELLENDICHTRING / OIL-SEAL
600/640/20 C NBR WELLENDICHTRING / OIL-SEAL
620/660/20 C NBR WELLENDICHTRING / OIL-SEAL
650/690/25 C NBR WELLENDICHTRING / OIL-SEAL
680/720/20 C NBR WELLENDICHTRING / OIL-SEAL
710/760/20 C NBR WELLENDICHTRING / OIL-SEAL
48/90/13 C FPM WELLENDICHTRING / OIL-SEAL,
50/65/8 CS FPM WELLENDICHTRING / OIL-SEAL
55/80/10 C FPM WELLENDICHTRING / OIL-SEAL
60/85/13 C FPM WELLENDICHTRING / OIL-SEAL
70/90/13 CS FPM WELLENDICHTRING / OIL-SEAL
70/100/10 C FPM WELLENDICHTRING / OIL-SEAL
75/100/12 C FPM WELLENDICHTRING / OIL-SEAL
75/100/13 CS FPM WELLENDICHTRING / OIL-SEAL
90/110/8 C FPM WELLENDICHTRING / OIL-SEAL
100/120/12 C FPM WELLENDICHTRING / OIL-SEAL
100/130/12 C FPM WELLENDICHTRING / OIL-SEAL
100/130/13 CS FPM WELLENDICHTRING / OIL-SEAL
101,6/127/12,7 C FPM WELLENDICHTRING / OIL-SEAL
105/140/13 CS FPM WELLENDICHTRING / OIL-SEAL
107,95/133,35/12,7 C FPM WELLENDICHTRING / OIL-SEAL
110/130/12 C FPM WELLENDICHTRING / OIL-SEAL
114,3/139,7/12,7 C FPM WELLENDICHTRING / OIL-SEAL
120,65/146,05/12,7 C FPM WELLENDICHTRING / OIL-SEAL
120/150/15 C FPM WELLENDICHTRING / OIL-SEAL
125/150/15 C FPM WELLENDICHTRING / OIL-SEAL
130/160/15 C FPM OSFB WELLENDICHTRING / OIL-SEAL
131,78/158,75/12,7 C FPM WELLENDICHTRING / OIL-SEAL
139,7/165,1/12,7 C FPM WELLENDICHTRING / OIL-SEAL
140/160/13 C FPM WELLENDICHTRING / OIL-SEAL
140/170/15 C FPM WELLENDICHTRING / OIL-SEAL
150/180/15 CS FPM WELLENDICHTRING / OIL-SEAL
160/190/15 C FPM WELLENDICHTRING / OIL-SEAL
160/190/15 CS FPM WELLENDICHTRING / OIL-SEAL
180/200/13 C FPM WELLENDICHTRING / OIL-SEAL
180/210/15 C FPM OSFB WELLENDICHTRING / OIL-SEAL
190/220/15 C FPM OSFB WELLENDICHTRING / OIL-SEAL
200/230/15 C FPM OSFB WELLENDICHTRING / OIL-SEAL
205/230/15 C FPM WELLENDICHTRING / OIL-SEAL
205/230/16 C FPM WELLENDICHTRING / OIL-SEAL
210/240/15 C FPM OSFB WELLENDICHTRING / OIL-SEAL
215/250/16 C FPM WELLENDICHTRING / OIL-SEAL
220/270/20 C FPM OSFB WELLENDICHTRING / OIL-SEAL
225/250/16 C FPM WELLENDICHTRING / OIL-SEAL
230/260/15 C FPM OSFB WELLENDICHTRING / OIL-SEAL

230/270/15 C FPM WELLENDICHTRING / OIL-SEAL
240/270/15 C FPM WELLENDICHTRING / OIL-SEAL
240/270/15 CS FPM WELLENDICHTRING / OIL-SEAL
240/280/16 C FPM WELLENDICHTRING / OIL-SEAL
250/280/15 C FPM OSFB WELLENDICHTRING / OIL-SEAL
250/280/15 CS FPM WELLENDICHTRING / OIL-SEAL
250/290/16 C FPM WELLENDICHTRING / OIL-SEAL
265/290/16 C FPM WELLENDICHTRING / OIL-SEAL
270/310/16 C FPM OSFB WELLENDICHTRING / OIL-SEAL
280/320/20 C FPM OSFB WELLENDICHTRING / OIL-SEAL
290/330/18 C FPM WELLENDICHTRING / OIL-SEAL
300/340/20 C FPM OSFB WELLENDICHTRING / OIL-SEAL
310/350/18 C FPM OSFB WELLENDICHTRING / OIL-SEAL
320/360/20 C FPM OSFB WELLENDICHTRING / OIL-SEAL
350/390/18 C FPM WELLENDICHTRING / OIL-SEAL
360/400/20 C FPM OSFB WELLENDICHTRING / OIL-SEAL
380/420/20 C FPM OSFB WELLENDICHTRING / OIL-SEAL*
400/440/20 C FPM OSFB WELLENDICHTRING / OIL-SEAL
420/460/20 C FPM OSFB WELLENDICHTRING / OIL-SEAL
440/480/20 C FPM OSFB WELLENDICHTRING / OIL-SEAL
460/500/20 C FPM OSFB WELLENDICHTRING / OIL-SEAL
480/520/20 C FPM WELLENDICHTRING / OIL-SEAL
490/530/20 C FPM OSFB WELLENDICHTRING / OIL-SEAL
500/540/20 C FPM OSFB WELLENDICHTRING / OIL-SEAL*
530/580/20 C FPM WELLENDICHTRING / OIL-SEAL
560/600/20 C FPM OSFB WELLENDICHTRING / OIL-SEAL
560/610/20 C FPM OSFB WELLENDICHTRING / OIL-SEAL
580/650/25 C FPM OSFB WELLENDICHTRING / OIL-SEAL
600/640/18 C FPM WELLENDICHTRING / OIL-SEAL
600/640/20 C FPM OSFB WELLENDICHTRING / OIL-SEAL
640/680/20 C FPM OSFB WELLENDICHTRING / OIL-SEAL
650/710/30 C FPM OSFB WELLENDICHTRING / OIL-SEAL
660/700/20 C FPM WELLENDICHTRING / OIL-SEAL
670/710/20 C FPM OSFB WELLENDICHTRING / OIL-SEAL
710/760/20 C FPM WELLENDICHTRING / OIL-SEAL
720/780/25 C FPM WELLENDICHTRING / OIL-SEAL
730/780/20 C FPM OSFB WELLENDICHTRING / OIL-SEAL
740/780/20 C FPM OSFB WELLENDICHTRING / OIL-SEAL
750/790/23 C FPM OSFB WELLENDICHTRING / OIL-SEAL
760/830/30 C FPM OSFB WELLENDICHTRING / OIL-SEAL
790/830/23 C FPM OSFB WELLENDICHTRING / OIL-SEAL
820/884/25 C FPM WELLENDICHTRING / OIL-SEAL
890/930/23 C FPM OSFB WELLENDICHTRING / OIL-SEAL

VERSCHLUSSKAPPEN / END COVER Caps

22 X 7	A-EC VERSCHLUSSKAPPEN / END COVER Cover NBR*
28 X 4	A-EC VERSCHLUSSKAPPEN / END COVER Cover NBR.
28 X 7	A-EC VERSCHLUSSKAPPEN / END COVER Cover NBR*
30 X 7	A-EC VERSCHLUSSKAPPEN / END COVER Cover NBR
32 X 7	A-EC VERSCHLUSSKAPPEN / END COVER Cover NBR*
35 X 7	A-EC VERSCHLUSSKAPPEN / END COVER Cover NBR*
35 X 8	A-EC VERSCHLUSSKAPPEN / END COVER Cover NBR*
37 X 5	A-EC VERSCHLUSSKAPPEN / END COVER Cover NBR*
37 X 7	A-EC VERSCHLUSSKAPPEN / END COVER Cover NBR
40 X 7	A-EC VERSCHLUSSKAPPEN / END COVER Cover NBR*
42 X 7	A-EC VERSCHLUSSKAPPEN / END COVER Cover NBR*
47 X 4	A-EC VERSCHLUSSKAPPEN / END COVER Cover NBR
47 X 7	A-EC VERSCHLUSSKAPPEN / END COVER Cover NBR*
47 X 10	A-EC VERSCHLUSSKAPPEN / END COVER Cover NBR*
52 X 7	A-EC VERSCHLUSSKAPPEN / END COVER Cover NBR*
52 X 10	A-EC VERSCHLUSSKAPPEN / END COVER Cover NBR*
55 X 10	A-EC VERSCHLUSSKAPPEN / END COVER Cover NBR*
62 X 7	A-EC VERSCHLUSSKAPPEN / END COVER Cover NBR*
62 X 8	A-EC VERSCHLUSSKAPPEN / END COVER Cover NBR*
62 X 10	A-EC VERSCHLUSSKAPPEN / END COVER Cover NBR*
65 X 8	A-EC VERSCHLUSSKAPPEN / END COVER Cover NBR.
65 X 10	A-EC VERSCHLUSSKAPPEN / END COVER Cover NBR.
68 X 8	A-EC VERSCHLUSSKAPPEN / END COVER Cover NBR*
72 X 9	A-EC VERSCHLUSSKAPPEN / END COVER Cover NBR*
75 X 7	A-EC VERSCHLUSSKAPPEN / END COVER Cover NBR.
80 X 10	A-EC VERSCHLUSSKAPPEN / END COVER Cover NBR*
80 X 12	A-EC VERSCHLUSSKAPPEN / END COVER Cover NBR*
85 X 12	A-EC VERSCHLUSSKAPPEN / END COVER Cover NBR
90 X 8	A-EC VERSCHLUSSKAPPEN / END COVER Cover NBR
90 X 10	A-EC VERSCHLUSSKAPPEN / END COVER Cover NBR*
90 X 12	A-EC VERSCHLUSSKAPPEN / END COVER Cover NBR*
100 X 10	A-EC VERSCHLUSSKAPPEN / END COVER Cover NBR*
100 X 12	A-EC VERSCHLUSSKAPPEN / END COVER Cover NBR
110 X 10	A-EC VERSCHLUSSKAPPEN / END COVER Cover NBR
110 X 12	A-EC VERSCHLUSSKAPPEN / END COVER Cover NBR
150 X 13	A-EC VERSCHLUSSKAPPEN / END COVER Cover NBR.
100 X 10	A-EC VERSCHLUSSKAPPEN / END Cover FPM

V-Ringe / V-Rings

10 VA EPDM V-RING / V-RINGS
55 VA EPDM V-RING / V-RINGS
3 VA NBR V-RING / V-RINGS*
5 VA NBR V-RING / V-RINGS*
6 VA NBR V-RING / V-RINGS*
7 VA NBR V-RING / V-RINGS*
8 VA NBR V-RING / V-RINGS*
10 VA NBR V-RING / V-RINGS*
12 VA NBR V-RING / V-RINGS*
14 VA NBR V-RING / V-RINGS*
16 VA NBR V-RING / V-RINGS*
18 VA NBR V-RING / V-RINGS*
20 VA NBR V-RING / V-RINGS*
22 VA NBR V-RING / V-RINGS*
25 VA NBR V-RING / V-RINGS*
28 VA NBR V-RING / V-RINGS*
30 VA NBR V-RING / V-RINGS*
32 VA NBR V-RING / V-RINGS*
35 VA NBR V-RING / V-RINGS*
38 VA NBR V-RING / V-RINGS*
40 VA NBR V-RING / V-RINGS*
45 VA NBR V-RING / V-RINGS*
50 VA NBR V-RING / V-RINGS*
55 VA NBR V-RING / V-RINGS*
60 VA NBR V-RING / V-RINGS*
65 VA NBR V-RING / V-RINGS*
70 VA NBR V-RING / V-RINGS*
85 VA NBR V-RING / V-RINGS*
90 VA NBR V-RING / V-RINGS*
95 VA NBR V-RING / V-RINGS*
100 VA NBR V-RING / V-RINGS*
110 VA NBR V-RING / V-RINGS*
120 VA NBR V-RING / V-RINGS*
130 VA NBR V-RING / V-RINGS*
140 VA NBR V-RING / V-RINGS*
150 VA NBR V-RING / V-RINGS*
160 VA NBR V-RING / V-RINGS*
170 VA NBR V-RING / V-RINGS*
180 VA NBR V-RING / V-RINGS*
190 VA NBR V-RING / V-RINGS*
220 VA NBR V-RING / V-RINGS*
250 VA NBR V-RING / V-RINGS*
275 VA NBR V-RING / V-RINGS*
300 VA NBR V-RING / V-RINGS*
325 VA NBR V-RING / V-RINGS*
350 VA NBR V-RING / V-RINGS*
375 VA NBR V-RING / V-RINGS*

400 VA NBR V-RING / V-RINGS*
450 VA NBR V-RING / V-RINGS*
500 VA NBR V-RING / V-RINGS*
550 VA NBR V-RING / V-RINGS*
600 VA NBR V-RING / V-RINGS*
700 VA NBR V-RING / V-RINGS*
725 VA NBR V-RING / V-RINGS*
750 VA NBR V-RING / V-RINGS*
850 VA NBR V-RING / V-RINGS*
900 VA NBR V-RING / V-RINGS*
950 VA NBR V-RING / V-RINGS*
1000 VA NBR V-RING / V-RINGS*
1050 VA NBR V-RING / V-RINGS*
1100 VA NBR V-RING / V-RINGS*
1150 VA NBR V-RING / V-RINGS*
1200 VA NBR V-RING / V-RINGS*
1250 VA NBR V-RING / V-RINGS*
1350 VA NBR V-RING / V-RINGS*
1400 VA NBR V-RING / V-RINGS*
1450 VA NBR V-RING / V-RINGS
1500 VA NBR V-RING / V-RINGS
1600 VA NBR V-RING / V-RINGS
1650 VA NBR V-RING / V-RINGS
1700 VA NBR V-RING / V-RINGS
1750 VA NBR V-RING / V-RINGS
1800 VA NBR V-RING / V-RINGS
1850 VA NBR V-RING / V-RINGS
1900 VA NBR V-RING / V-RINGS
1950 VA NBR V-RING / V-RINGS
2150 VA NBR V-RING / V-RINGS*
150 VA NEO V-RING / V-RINGS
300 VA NEO V-RING / V-RINGS
700 VA NEO V-RING / V-RINGS
800 VA NEO V-RING / V-RINGS
3 VA FPM V-RING / V-RINGS*
4 VA FPM V-RING / V-RINGS*
5 VA FPM V-RING / V-RINGS*
6 VA FPM V-RING / V-RINGS*
7 VA FPM V-RING / V-RINGS*
8 VA FPM V-RING / V-RINGS*
10 VA FPM V-RING / V-RINGS*
12 VA FPM V-RING / V-RINGS*
16 VA FPM V-RING / V-RINGS*
18 VA FPM V-RING / V-RINGS*
20 VA FPM V-RING / V-RINGS*
25 VA FPM V-RING / V-RINGS*
28 VA FPM V-RING / V-RINGS*
30 VA FPM V-RING / V-RINGS*
32 VA FPM V-RING / V-RINGS*
35 VA FPM V-RING / V-RINGS*

38 VA FPM V-RING / V-RINGS*
40 VA FPM V-RING / V-RINGS*
45 VA FPM V-RING / V-RINGS*
50 VA FPM V-RING / V-RINGS*
60 VA FPM V-RING / V-RINGS*
65 VA FPM V-RING / V-RINGS*
70 VA FPM V-RING / V-RINGS*
75 VA FPM V-RING / V-RINGS*
80 VA FPM V-RING / V-RINGS*
85 VA FPM V-RING / V-RINGS*
90 VA FPM V-RING / V-RINGS*
95 VA FPM V-RING / V-RINGS*
100 VA FPM V-RING / V-RINGS*
110 VA FPM V-RING / V-RINGS*
120 VA FPM V-RING / V-RINGS*
130 VA FPM V-RING / V-RINGS*
150 VA FPM V-RING / V-RINGS*
160 VA FPM V-RING / V-RINGS*
170 VA FPM V-RING / V-RINGS*
180 VA FPM V-RING / V-RINGS*
190 VA FPM V-RING / V-RINGS*
199 VA FPM V-RING / V-RINGS*
200 VA FPM V-RING / V-RINGS*
220 VA FPM V-RING / V-RINGS*
250 VA FPM V-RING / V-RINGS*
275 VA FPM V-RING / V-RINGS*
300 VA FPM V-RING / V-RINGS*
325 VA FPM V-RING / V-RINGS*
375 VA FPM V-RING / V-RINGS*
400 VA FPM V-RING / V-RINGS*
450 VA FPM V-RING / V-RINGS*
500 VA FPM V-RING / V-RINGS*
550 VA FPM V-RING / V-RINGS*
600 VA FPM V-RING / V-RINGS*
650 VA FPM V-RING / V-RINGS*
700 VA FPM V-RING / V-RINGS*
725 VA FPM V-RING / V-RINGS*
750 VA FPM V-RING / V-RINGS*
800 VA FPM V-RING / V-RINGS*
850 VA FPM V-RING / V-RINGS*
900 VA FPM V-RING / V-RINGS*
950 VA FPM V-RING / V-RINGS*
1000 VA FPM V-RING / V-RINGS*
1050 VA FPM V-RING / V-RINGS*
1100 VA FPM V-RING / V-RINGS*
1150 VA FPM V-RING / V-RINGS*
1200 VA FPM V-RING / V-RINGS*
1250 VA FPM V-RING / V-RINGS*
1300 VA FPM V-RING / V-RINGS
1450 VA FPM V-RING / V-RINGS

1500 VA FPM V-RING / V-RINGS
1650 VA FPM V-RING / V-RINGS
220 VAX NBR V-RING / V-RINGS
260 VAX NBR V-RING / V-RINGS
280 VAX NBR V-RING / V-RINGS
300 VAX NBR V-RING / V-RINGS*
310 VAX NBR V-RING / V-RINGS
350 VAX NBR V-RING / V-RINGS*
375 VAX NBR V-RING / V-RINGS
400 VAX NBR V-RING / V-RINGS*
425 VAX NBR V-RING / V-RINGS
450 VAX NBR V-RING / V-RINGS*
500 VAX NBR V-RING / V-RINGS*
550 VAX NBR V-RING / V-RINGS*
600 VAX NBR V-RING / V-RINGS*
650 VAX NBR V-RING / V-RINGS
700 VAX NBR V-RING / V-RINGS
725 VAX NBR V-RING / V-RINGS*
850 VAX NBR V-RING / V-RINGS*
950 VAX NBR V-RING / V-RINGS*
1000 VAX NBR V-RING / V-RINGS
1050 VAX NBR V-RING / V-RINGS
1100 VAX NBR V-RING / V-RINGS*
1300 VAX NBR V-RING / V-RINGS
1350 VAX NBR V-RING / V-RINGS
1650 VAX NBR V-RING / V-RINGS
1850 VAX NBR V-RING / V-RINGS
1900 VAX NBR V-RING / V-RINGS
1950 VAX NBR V-RING / V-RINGS
850 VAX NEO V-RING / V-RINGS
950 VAX SIL V-RING / V-RINGS
350 VAX FPM V-RING / V-RINGS*
600 VAX FPM V-RING / V-RINGS
850 VAX FPM V-RING / V-RINGS*
1050 VAX FPM V-RING / V-RINGS
1000 VE EPDM V-RING / V-RINGS
1100 VE EPDM V-RING / V-RINGS
810 VE HNBR V-RING / V-RINGS*
305 VE NBR V-RING / V-RINGS
310 VE NBR V-RING / V-RINGS
330 VE NBR V-RING / V-RINGS
345 VE NBR V-RING / V-RINGS
350 VE NBR V-RING / V-RINGS*
390 VE NBR V-RING / V-RINGS*
400 VE NBR V-RING / V-RINGS*
410 VE NBR V-RING / V-RINGS*
420 VE NBR V-RING / V-RINGS
425 VE NBR V-RING / V-RINGS
440 VE NBR V-RING / V-RINGS*
450 VE NBR V-RING / V-RINGS*

460 VE NBR V-RING / V-RINGS*
480 VE NBR V-RING / V-RINGS*
500 VE NBR V-RING / V-RINGS*
530 VE NBR V-RING / V-RINGS
540 VE NBR V-RING / V-RINGS*
560 VE NBR V-RING / V-RINGS
560 VE NBR V-RING / V-RINGS
575 VE NBR V-RING / V-RINGS*
580 VE NBR V-RING / V-RINGS*
585 VE NBR V-RING / V-RINGS*
600 VE NBR V-RING / V-RINGS*
610 VE NBR V-RING / V-RINGS*
620 VE NBR V-RING / V-RINGS
630 VE NBR V-RING / V-RINGS
650 VE NBR V-RING / V-RINGS
660 VE NBR V-RING / V-RINGS
670 VE NBR V-RING / V-RINGS
690 VE NBR V-RING / V-RINGS*
700 VE NBR V-RING / V-RINGS*
740 VE NBR V-RING / V-RINGS*
780 VE NBR V-RING / V-RINGS
800 VE NBR V-RING / V-RINGS
820 VE NBR V-RING / V-RINGS
830 VE NBR V-RING / V-RINGS
840 VE NBR V-RING / V-RINGS*
880 VE NBR V-RING / V-RINGS
900 VE NBR V-RING / V-RINGS*
920 VE NBR V-RING / V-RINGS
990 VE NBR V-RING / V-RINGS
1000 VE NBR V-RING / V-RINGS*
1100 VE NBR V-RING / V-RINGS*
1240 VE NBR V-RING / V-RINGS
1300 VE NBR V-RING / V-RINGS
1425 VE NBR V-RING / V-RINGS
1700 VE NBR V-RING / V-RINGS
390 VE FPM V-RING / V-RINGS*
450 VE FPM V-RING / V-RINGS*
550 VE FPM V-RING / V-RINGS
560 VE FPM V-RING / V-RINGS
600 VE FPM V-RING / V-RINGS*
1000 VE FPM V-RING / V-RINGS*
1100 VE FPM V-RING / V-RINGS
110 VL NBR V-RING / V-RINGS*
120 VL NBR V-RING / V-RINGS*
130 VL NBR V-RING / V-RINGS*
140 VL NBR V-RING / V-RINGS*
150 VL NBR V-RING / V-RINGS*
160 VL NBR V-RING / V-RINGS*
170 VL NBR V-RING / V-RINGS*
180 VL NBR V-RING / V-RINGS*

190 VL NBR V-RING / V-RINGS*
200 VL NBR V-RING / V-RINGS*
220 VL NBR V-RING / V-RINGS*
250 VL NBR V-RING / V-RINGS*
275 VL NBR V-RING / V-RINGS*
300 VL NBR V-RING / V-RINGS*
325 VL NBR V-RING / V-RINGS*
350 VL NBR V-RING / V-RINGS*
375 VL NBR V-RING / V-RINGS*
400 VL NBR V-RING / V-RINGS*
425 VL NBR V-RING / V-RINGS*
450 VL NBR V-RING / V-RINGS*
500 VL NBR V-RING / V-RINGS*
525 VL NBR V-RING / V-RINGS
550 VL NBR V-RING / V-RINGS*
600 VL NBR V-RING / V-RINGS*
650 VL NBR V-RING / V-RINGS*
700 VL NBR V-RING / V-RINGS*
725 VL NBR V-RING / V-RINGS
750 VL NBR V-RING / V-RINGS*
800 VL NBR V-RING / V-RINGS
850 VL NBR V-RING / V-RINGS*
900 VL NBR V-RING / V-RINGS*
950 VL NBR V-RING / V-RINGS
1000 VL NBR V-RING / V-RINGS
1050 VL NBR V-RING / V-RINGS
1300 VL NBR V-RING / V-RINGS
1800 VL NBR V-RING / V-RINGS
400 VL SIL V-RING / V-RINGS
120 VL FPM V-RING / V-RINGS*
130 VL FPM V-RING / V-RINGS*
140 VL FPM V-RING / V-RINGS*
150 VL FPM V-RING / V-RINGS*
160 VL FPM V-RING / V-RINGS*
170 VL FPM V-RING / V-RINGS*
180 VL FPM V-RING / V-RINGS*
190 VL FPM V-RING / V-RINGS*
200 VL FPM V-RING / V-RINGS*
220 VL FPM V-RING / V-RINGS*
250 VL FPM V-RING / V-RINGS*
275 VL FPM V-RING / V-RINGS*
300 VL FPM V-RING / V-RINGS*
325 VL FPM V-RING / V-RINGS*
350 VL FPM V-RING / V-RINGS*
375 VL FPM V-RING / V-RINGS*
400 VL FPM V-RING / V-RINGS*
425 VL FPM V-RING / V-RINGS*
450 VL FPM V-RING / V-RINGS*
500 VL FPM V-RING / V-RINGS*
525 VL FPM V-RING / V-RINGS

550 VL FPM V-RING / V-RINGS*
600 VL FPM V-RING / V-RINGS*
700 VL FPM V-RING / V-RINGS*
725 VL FPM V-RING / V-RINGS
750 VL FPM V-RING / V-RINGS*
850 VL FPM V-RING / V-RINGS*
950 VL FPM V-RING / V-RINGS
1150 VL FPM V-RING / V-RINGS
120 VXL NBR V-RING / V-RINGS
160 VXL NBR V-RING / V-RINGS
220 VLX NBR V-RING / V-RINGS
120 VXL FPM V-RING / V-RINGS
140 VLX FPM V-RING / V-RINGS
160 VXL FPM V-RING / V-RINGS
280 VRMEX NBR V-RING / V-RINGS
5 VS NBR V-RING / V-RINGS*
6 VS NBR V-RING / V-RINGS*
7 VS NBR V-RING / V-RINGS*
8 VS NBR V-RING / V-RINGS*
10 VS NBR V-RING / V-RINGS*
12 VS NBR V-RING / V-RINGS*
14 VS NBR V-RING / V-RINGS*
16 VS NBR V-RING / V-RINGS*
18 VS NBR V-RING / V-RINGS*
20 VS NBR V-RING / V-RINGS*
22 VS NBR V-RING / V-RINGS*
25 VS NBR V-RING / V-RINGS*
28 VS NBR V-RING / V-RINGS*
30 VS NBR V-RING / V-RINGS*
32 VS NBR V-RING / V-RINGS*
35 VS NBR V-RING / V-RINGS*
38 VS NBR V-RING / V-RINGS*
40 VS NBR V-RING / V-RINGS*
45 VS NBR V-RING / V-RINGS*
55 VS NBR V-RING / V-RINGS*
60 VS NBR V-RING / V-RINGS*
65 VS NBR V-RING / V-RINGS*
70 VS NBR V-RING / V-RINGS*
75 VS NBR V-RING / V-RINGS*
80 VS NBR V-RING / V-RINGS*
85 VS NBR V-RING / V-RINGS*
90 VS NBR V-RING / V-RINGS*
95 VS NBR V-RING / V-RINGS*
100 VS NBR V-RING / V-RINGS*
110 VS NBR V-RING / V-RINGS*
120 VS NBR V-RING / V-RINGS*
130 VS NBR V-RING / V-RINGS*
140 VS NBR V-RING / V-RINGS*
150 VS NBR V-RING / V-RINGS*
160 VS NBR V-RING / V-RINGS*

170 VS NBR V-RING / V-RINGS*
180 VS NBR V-RING / V-RINGS*
190 VS NBR V-RING / V-RINGS*
199 VS NBR V-RING / V-RINGS*
5 VS FPM V-RING / V-RINGS*
6 VS FPM V-RING / V-RINGS*
7 VS FPM V-RING / V-RINGS*
8 VS FPM V-RING / V-RINGS*
10 VS FPM V-RING / V-RINGS*
12 VS FPM V-RING / V-RINGS*
14 VS FPM V-RING / V-RINGS*
16 VS FPM V-RING / V-RINGS*
18 VS FPM V-RING / V-RINGS*
20 VS FPM V-RING / V-RINGS*
22 VS FPM V-RING / V-RINGS*
25 VS FPM V-RING / V-RINGS*
28 VS FPM V-RING / V-RINGS*
30 VS FPM V-RING / V-RINGS*
32 VS FPM V-RING / V-RINGS*
35 VS FPM V-RING / V-RINGS*
38 VS FPM V-RING / V-RINGS*
40 VS FPM V-RING / V-RINGS*
45 VS FPM V-RING / V-RINGS*
50 VS FPM V-RING / V-RINGS*
55 VS FPM V-RING / V-RINGS*
60 VS FPM V-RING / V-RINGS*
65 VS FPM V-RING / V-RINGS*
70 VS FPM V-RING / V-RINGS*
75 VS FPM V-RING / V-RINGS*
80 VS FPM V-RING / V-RINGS*
85 VS FPM V-RING / V-RINGS*
90 VS FPM V-RING / V-RINGS*
95 VS FPM V-RING / V-RINGS*
100 VS FPM V-RING / V-RINGS*
110 VS FPM V-RING / V-RINGS*
120 VS FPM V-RING / V-RINGS*
130 VS FPM V-RING / V-RINGS*
140 VS FPM V-RING / V-RINGS*
150 VS FPM V-RING / V-RINGS*
160 VS FPM V-RING / V-RINGS*
170 VS FPM V-RING / V-RINGS*
180 VS FPM V-RING / V-RINGS*
190 VS FPM V-RING / V-RINGS*
199 VS FPM V-RING / V-RINGS*

AXIALDICHTRING / AXIAL-SEAL

Gamma-Dichtringe ®

Die AXI 01 und AXI 02 sind Axialdichtungen, die aus zwei Bauteilen bestehen, einem beschichteten Metallring und einem aus der Form vulkanisierten Elastomerdichtelement. Der Metallring schützt die Elastomerdichtung gegen Beschädigungen, dient als Halterung und Abstützung der Elastomerdichtung und wirkt gleichzeitig als Schleuderscheibe.

Die Elastomerdichtung ist nicht fest an den Metallring gebunden, sondern auf den Metallring aufgedehnt und wird zusätzlich durch den axialen Bördelbund gehalten. Bei dem AXI 02 ist der Metallring am Außenmantel in axialer Richtung verlängert. In Kombination mit der umlaufenden Nut in der axialen Gegenlauffläche wird eine zusätzliche Labyrinthabdichtung gebildet.

The AXI 01 and AXI 02 are axial seals consisting of 2 sections, one coated metal ring and one mould vulcanised elastomer sealing element.

The metal ring protects the elastomer seal against damage, serves as a stand and support for the elastomer seal and simultaneously acts as a flinger. The elastomer seal is not firmly bonded to but stretched over the metal ring and is additionally held by the axial flange.

With the AXI 02 the metal ring is extended in an axial direction on the outer sheath. Additional labyrinth sealing is created in combination with the circulating groove in the sliding surface.

10/24/3,5 AXI 1 FKM AXIALDICHTUNG / AXIAL SEAL
10/24/3,5 AXI 1 NBR AXIALDICHTUNG / AXIAL SEAL
11/26/3,5 AXI 1 FKM AXIALDICHTUNG / AXIAL SEAL
11/26/3,5 AXI 1 NBR AXIALDICHTUNG / AXIAL SEAL
12/26/3,5 AXI 1 FKM AXIALDICHTUNG / AXIAL SEAL
12/26/3,5 AXI 1 NBR AXIALDICHTUNG / AXIAL SEAL
14/30/4 AXI 1 FKM AXIALDICHTUNG / AXIAL SEAL
14/30/4 AXI 1 NBR AXIALDICHTUNG / AXIAL SEAL
15/30/4 AXI 1 FKM AXIALDICHTUNG / AXIAL SEAL
15/30/4 AXI 1 NBR AXIALDICHTUNG / AXIAL SEAL
15/32/4 AXI 2 FKM AXIALDICHTUNG / AXIAL SEAL
15/32/4 AXI 2 NBR AXIALDICHTUNG / AXIAL SEAL
16/32/4 AXI 1 FKM AXIALDICHTUNG / AXIAL SEAL
16/32/4 AXI 1 NBR AXIALDICHTUNG / AXIAL SEAL
17/32/4 AXI 1 FKM AXIALDICHTUNG / AXIAL SEAL
17/32/4 AXI 1 NBR AXIALDICHTUNG / AXIAL SEAL
17/34/4 AXI 2 FKM AXIALDICHTUNG / AXIAL SEAL
17/34/4 AXI 2 NBR AXIALDICHTUNG / AXIAL SEAL
18/33/4 AXI 1 FKM AXIALDICHTUNG / AXIAL SEAL
18/33/4 AXI 1 NBR AXIALDICHTUNG / AXIAL SEAL
20/35/4 AXI 1 FKM AXIALDICHTUNG / AXIAL SEAL
20/35/4 AXI 1 NBR AXIALDICHTUNG / AXIAL SEAL
20/37/4 AXI 2 FKM AXIALDICHTUNG / AXIAL SEAL
20/37/4 AXI 2 NBR AXIALDICHTUNG / AXIAL SEAL
22/40/4 AXI 1 FKM AXIALDICHTUNG / AXIAL SEAL
22/40/4 AXI 1 NBR AXIALDICHTUNG / AXIAL SEAL
24/40/4 AXI 1 FKM AXIALDICHTUNG / AXIAL SEAL
24/40/4 AXI 1 NBR AXIALDICHTUNG / AXIAL SEAL
25/40/4 AXI 1 FKM AXIALDICHTUNG / AXIAL SEAL
25/40/4 AXI 1 NBR AXIALDICHTUNG / AXIAL SEAL
25/42/4 AXI 2 FKM AXIALDICHTUNG / AXIAL SEAL
25/42/4 AXI 2 NBR AXIALDICHTUNG / AXIAL SEAL
26/40/4 AXI 1 FKM AXIALDICHTUNG / AXIAL SEAL
26/40/4 AXI 1 NBR AXIALDICHTUNG / AXIAL SEAL
28/43/4 AXI 1 FKM AXIALDICHTUNG / AXIAL SEAL
28/43/4 AXI 1 NBR AXIALDICHTUNG / AXIAL SEAL
30/47/4,5 AXI 1 FKM AXIALDICHTUNG / AXIAL SEAL
30/47/4,5 AXI 1 NBR AXIALDICHTUNG / AXIAL SEAL
30/48/4,5 AXI 2 FKM AXIALDICHTUNG / AXIAL SEAL
30/48/4,5 AXI 2 NBR AXIALDICHTUNG / AXIAL SEAL
32/49/4,5 AXI 1 FKM AXIALDICHTUNG / AXIAL SEAL
32/49/4,5 AXI 1 NBR AXIALDICHTUNG / AXIAL SEAL
35/52/4,5 AXI 1 FKM AXIALDICHTUNG / AXIAL SEAL
35/52/4,5 AXI 1 NBR AXIALDICHTUNG / AXIAL SEAL
35/53/4,5 AXI 2 FKM AXIALDICHTUNG / AXIAL SEAL
35/53/4,5 AXI 2 NBR AXIALDICHTUNG / AXIAL SEAL
38/55/4,5 AXI 1 FKM AXIALDICHTUNG / AXIAL SEAL

38/55/4,5 AXI 1 NBR AXIALDICHTUNG / AXIAL SEAL
40/57/4,5 AXI 1 FKM AXIALDICHTUNG / AXIAL SEAL
40/57/4,5 AXI 1 NBR AXIALDICHTUNG / AXIAL SEAL
40/58/4,5 AXI 2 FKM AXIALDICHTUNG / AXIAL SEAL
40/58/4,5 AXI 2 NBR AXIALDICHTUNG / AXIAL SEAL
41/57/4,5 AXI 1 FKM AXIALDICHTUNG / AXIAL SEAL
41/57/4,5 AXI 1 NBR AXIALDICHTUNG / AXIAL SEAL
42/59/4,5 AXI 1 FKM AXIALDICHTUNG / AXIAL SEAL
42/59/4,5 AXI 1 NBR AXIALDICHTUNG / AXIAL SEAL
45/62/4,5 AXI 1 FKM AXIALDICHTUNG / AXIAL SEAL
45/62/4,5 AXI 1 NBR AXIALDICHTUNG / AXIAL SEAL
45/63/4,5 AXI 2 FKM AXIALDICHTUNG / AXIAL SEAL
45/63/4,5 AXI 2 NBR AXIALDICHTUNG / AXIAL SEAL
48/65/4,5 AXI 1 FKM AXIALDICHTUNG / AXIAL SEAL
48/65/4,5 AXI 1 NBR AXIALDICHTUNG / AXIAL SEAL
50/70/5,5 AXI 1 FKM AXIALDICHTUNG / AXIAL SEAL
50/70/5,5 AXI 1 NBR AXIALDICHTUNG / AXIAL SEAL
50/72/5,5 AXI 2 FKM AXIALDICHTUNG / AXIAL SEAL
50/72/5,5 AXI 2 NBR AXIALDICHTUNG / AXIAL SEAL
52/72/5,5 AXI 1 FKM AXIALDICHTUNG / AXIAL SEAL
52/72/5,5 AXI 1 NBR AXIALDICHTUNG / AXIAL SEAL
55/75/5,5 AXI 1 FKM AXIALDICHTUNG / AXIAL SEAL
55/75/5,5 AXI 1 NBR AXIALDICHTUNG / AXIAL SEAL
55/77/5,5 AXI 2 FKM AXIALDICHTUNG / AXIAL SEAL
55/77/5,5 AXI 2 NBR AXIALDICHTUNG / AXIAL SEAL
58/78/5,5 AXI 1 FKM AXIALDICHTUNG / AXIAL SEAL
58/78/5,5 AXI 1 NBR AXIALDICHTUNG / AXIAL SEAL
60/80/5,5 AXI 1 FKM AXIALDICHTUNG / AXIAL SEAL
60/80/5,5 AXI 1 NBR AXIALDICHTUNG / AXIAL SEAL
60/82/5,5 AXI 2 FKM AXIALDICHTUNG / AXIAL SEAL
60/82/5,5 AXI 2 NBR AXIALDICHTUNG / AXIAL SEAL
62/82/5,5 AXI 1 FKM AXIALDICHTUNG / AXIAL SEAL
62/82/5,5 AXI 1 NBR AXIALDICHTUNG / AXIAL SEAL
65/85/5,5 AXI 1 FKM AXIALDICHTUNG / AXIAL SEAL
65/85/5,5 AXI 1 NBR AXIALDICHTUNG / AXIAL SEAL
65/87/5,5 AXI 2 FKM AXIALDICHTUNG / AXIAL SEAL
65/87/5,5 AXI 2 NBR AXIALDICHTUNG / AXIAL SEAL
68/88/5,5 AXI 1 FKM AXIALDICHTUNG / AXIAL SEAL
68/88/5,5 AXI 1 NBR AXIALDICHTUNG / AXIAL SEAL
70/90/5,5 AXI 1 FKM AXIALDICHTUNG / AXIAL SEAL
70/90/5,5 AXI 1 NBR AXIALDICHTUNG / AXIAL SEAL
70/92/5,5 AXI 2 FKM AXIALDICHTUNG / AXIAL SEAL
70/92/5,5 AXI 2 NBR AXIALDICHTUNG / AXIAL SEAL
72/92/5,5 AXI 1 FKM AXIALDICHTUNG / AXIAL SEAL
72/92/5,5 AXI 1 NBR AXIALDICHTUNG / AXIAL SEAL
75/95/5,5 AXI 1 FKM AXIALDICHTUNG / AXIAL SEAL
75/95/5,5 AXI 1 NBR AXIALDICHTUNG / AXIAL SEAL
75/97/5,5 AXI 2 FKM AXIALDICHTUNG / AXIAL SEAL
75/97/5,5 AXI 2 NBR AXIALDICHTUNG / AXIAL SEAL
78/98/5,5 AXI 1 FKM AXIALDICHTUNG / AXIAL SEAL
78/98/5,5 AXI 1 NBR AXIALDICHTUNG / AXIAL SEAL
80/100/5,5 AXI 1 FKM AXIALDICHTUNG / AXIAL SEAL
80/100/5,5 AXI 1 NBR AXIALDICHTUNG / AXIAL SEAL
80/102/5,5 AXI 2 FKM AXIALDICHTUNG / AXIAL SEAL
80/102/5,5 AXI 2 NBR AXIALDICHTUNG / AXIAL SEAL
85/105/5,5 AXI 1 FKM AXIALDICHTUNG / AXIAL SEAL
85/105/5,5 AXI 1 NBR AXIALDICHTUNG / AXIAL SEAL
85/107/5,5 AXI 2 FKM AXIALDICHTUNG / AXIAL SEAL
85/107/5,5 AXI 2 NBR AXIALDICHTUNG / AXIAL SEAL
90/110/5,5 AXI 1 FKM AXIALDICHTUNG / AXIAL SEAL
90/110/5,5 AXI 1 NBR AXIALDICHTUNG / AXIAL SEAL
90/112/5,5 AXI 2 FKM AXIALDICHTUNG / AXIAL SEAL
90/112/5,5 AXI 2 NBR AXIALDICHTUNG / AXIAL SEAL
95/115/5,5 AXI 1 FKM AXIALDICHTUNG / AXIAL SEAL

95/115/5,5 AXI 1 NBR AXIALDICHTUNG / AXIAL SEAL
95/117/5,5 AXI 2 FKM AXIALDICHTUNG / AXIAL SEAL
95/117/5,5 AXI 2 NBR AXIALDICHTUNG / AXIAL SEAL
100/120/5,5 AXI 1 FKM AXIALDICHTUNG / AXIAL SEAL
100/120/5,5 AXI 1 NBR AXIALDICHTUNG / AXIAL SEAL
100/122/5,5 AXI 2 FKM AXIALDICHTUNG / AXIAL SEAL
100/122/5,5 AXI 2 NBR AXIALDICHTUNG / AXIAL SEAL
105/125/5,5 AXI 1 FKM AXIALDICHTUNG / AXIAL SEAL
105/125/5,5 AXI 1 NBR AXIALDICHTUNG / AXIAL SEAL
110/130/5,5 AXI 1 FKM AXIALDICHTUNG / AXIAL SEAL
120/140/5,5 AXI 1 NBR AXIALDICHTUNG / AXIAL SEAL
135/159/6,5 AXI 1 FKM AXIALDICHTUNG / AXIAL SEAL
135/159/6,5 AXI 1 NBR AXIALDICHTUNG / AXIAL SEAL
190/214/5,5 AXI 1 FKM AXIALDICHTUNG / AXIAL SEAL

WELLENSCHUTZHÜLLEN / SPEEDI-SLEEVE

Sie kennen das Problem: durch Schlamm, Sand und Schmutz sind Einlaufspuren in der Welle entstanden, so daß Radial Wellendichtringe keine einwandfreie Abdichtung mehr geben.

Abhilfe: Auswechseln oder Reparieren der Welle, eine kostspielige Reparatur und lange Stillstandszeiten.

Die Lösung bietet hier die Wellenschutzhülse aus Rostfreistahl reparieren Sie die Welle im Handumdrehen.

Man braucht die Welle nicht ausbauen
Geeignet für allerlei Wellenarten

Bemerkung:

Die Wellenschutzhülse hat derartige Abmessung, daß sie beim Einbau einigermaßen aufgedreht wird und sich somit selbst festklemmt.

Einbau der Wellenschutzhülse:

Die Wellenoberfläche reinigen und entgraten.

Die Welle an der betreffenden Stelle mit Flüssigpackung einschmieren. Tiefe Einlaufspuren mit Kunstharz ausgleichen.

Den Flansch der Wellenschutzhülse am Wellen-Ende anbringen.

Mit Hilfe des mitgelieferten Montagewerkzeuges bringt man die Hülse mit Hammerschlägen an die gewünschte Stelle. Nötigenfalls könnte man den Flanschrand der Schutzhülse durchschneiden, am Bruchrand abreißen und gegebenenfalls mit Schmirgelleinen nachbehandeln.

You recognize the problem: sand, mud and dirt have left their scoring marks on the shaft, which will prevent any oil seal from sealing effectively!

The remedy of renewing or repairing the shaft is a costly exercise and, in addition, causes quite some downtime.

The Sleeve or Speedi-Sleeve offers the perfect solution, allowing the shaft to be repaired in less than no time with the help of this ultra-thin stainless steel shaft bushing.

The shaft does not need to be removed
Suitable for a wide range of shaft sizes

N.B.:

The Speedi-Sleeve has been dimensioned so that it slightly expands during installation to provide a press fit.

Assembly:

Clean and debur the shaft surface.

Apply a little sealant to the shaft and fill deep scores with the help of synthetic resin.

Place the flange of the sleeve round the shaft end.

Tap the sleeve in place with the help of the assembly tool supplied.

If necessary, cut the flange of the sleeve at the pre-cut groove, tear it away and finish it with emery cloth.

12/15,5/6/8,4 WELLENSCHUTZHÜLLE / SPEEDI-SLEEVE
14/19,1/6,3/9,9 WELLENSCHUTZHÜLLE / SPEEDI-SLEEVE
15/19,1/5/9 WELLENSCHUTZHÜLLE / SPEEDI-SLEEVE
15,88/19,1/8/10,3 WELLENSCHUTZHÜLLE / SPEEDI-SLEEVE
16/18,2/8/11,1 WELLENSCHUTZHÜLLE / SPEEDI-SLEEVE
17/22,2/8/11 WELLENSCHUTZHÜLLE / SPEEDI-SLEEVE
17,93/22,4/8/11 WELLENSCHUTZHÜLLE / SPEEDI-SLEEVE
19,05/24/8/11,1 WELLENSCHUTZHÜLLE / SPEEDI-SLEEVE
20/23,6/8/11 WELLENSCHUTZHÜLLE / SPEEDI-SLEEVE
22/30,2/6,6/9,1 WELLENSCHUTZHÜLLE / SPEEDI-SLEEVE
22/30,2/8/12 WELLENSCHUTZHÜLLE / SPEEDI-SLEEVE
24/28,7/8/11 WELLENSCHUTZHÜLLE / SPEEDI-SLEEVE
25/33/8/11 WELLENSCHUTZHÜLLE / SPEEDI-SLEEVE
25,4/31/8/11,1 WELLENSCHUTZHÜLLE / SPEEDI-SLEEVE
26,01/33,4/8/12 WELLENSCHUTZHÜLLE / SPEEDI-SLEEVE
28/34,9/9,5/12,7 WELLENSCHUTZHÜLLE / SPEEDI-SLEEVE
28,58/38,1/9,5/12,7 WELLENSCHUTZHÜLLE / SPEEDI-SLEEVE
29,36/34,3/9,5/12,7 WELLENSCHUTZHÜLLE / SPEEDI-SLEEVE
29,85/35,6/8/11,1 WELLENSCHUTZHÜLLE / SPEEDI-SLEEVE
30/35,6/8/11 WELLENSCHUTZHÜLLE / SPEEDI-SLEEVE
30,18/35,6/8/11,1 WELLENSCHUTZHÜLLE / SPEEDI-SLEEVE
31,8/38,1/8/11,1 WELLENSCHUTZHÜLLE / SPEEDI-SLEEVE
32/38,1/8/11,1 WELLENSCHUTZHÜLLE / SPEEDI-SLEEVE
33,35/40,5/12,7/15,9 WELLENSCHUTZHÜLLE / SPEEDI-SLEEVE
34,93/41,6/12,7/15,9 WELLENSCHUTZHÜLLE / SPEEDI-SLEEVE
34,93/41,6/13/16 WELLENSCHUTZHÜLLE / SPEEDI-SLEEVE
36/45,2/13/17 WELLENSCHUTZHÜLLE / SPEEDI-SLEEVE
38/45,2/13/17 WELLENSCHUTZHÜLLE / SPEEDI-SLEEVE
38,1/45,2/9,5/12,7 WELLENSCHUTZHÜLLE / SPEEDI-SLEEVE
38,1/45,2/14,3/17,5 WELLENSCHUTZHÜLLE / SPEEDI-SLEEVE
38,68/47,2/11,1/14,3 WELLENSCHUTZHÜLLE / SPEEDI-SLEEVE
39,42/47,2/11,1/14,3 WELLENSCHUTZHÜLLE / SPEEDI-SLEEVE
39,7/47,2/14,3/17,5 WELLENSCHUTZHÜLLE / SPEEDI-SLEEVE
40/46,9/9,9/12,9 WELLENSCHUTZHÜLLE / SPEEDI-SLEEVE

40,08/47/13/16 WELLENSCHUTZHÜLLE / SPEEDI-SLEEVE
41/49,2/12,7/15,9 WELLENSCHUTZHÜLLE / SPEEDI-SLEEVE
41,9/53/11,3/14,5 WELLENSCHUTZHÜLLE / SPEEDI-SLEEVE
41,9/53/14,3/17,5 WELLENSCHUTZHÜLLE / SPEEDI-SLEEVE
42,06/53/14/17,5 WELLENSCHUTZHÜLLE / SPEEDI-SLEEVE
42,88/48,4/14,3/17,5 WELLENSCHUTZHÜLLE / SPEEDI-SLEEVE
43,66/51,6/14,3/17,5 WELLENSCHUTZHÜLLE / SPEEDI-SLEEVE
44,17/52,4/9,5/12,7 WELLENSCHUTZHÜLLE / SPEEDI-SLEEVE
44,45/52,4/14,3/17,5 WELLENSCHUTZHÜLLE / SPEEDI-SLEEVE
44,86/52,4/14,3/17,5 WELLENSCHUTZHÜLLE / SPEEDI-SLEEVE
45/53/14/17 WELLENSCHUTZHÜLLE / SPEEDI-SLEEVE
46,05/53,1/14,3/17,5 WELLENSCHUTZHÜLLE / SPEEDI-SLEEVE
48,03/56/14/17 WELLENSCHUTZHÜLLE / SPEEDI-SLEEVE
50/57/14/17 WELLENSCHUTZHÜLLE / SPEEDI-SLEEVE
50,3/58,8/14,3/17,9 WELLENSCHUTZHÜLLE / SPEEDI-SLEEVE
50,8/61,1/14,3/17,5 WELLENSCHUTZHÜLLE / SPEEDI-SLEEVE
52/62,7/12,7/15,9 WELLENSCHUTZHÜLLE / SPEEDI-SLEEVE
53,98/61,5/12,7/19,1 WELLENSCHUTZHÜLLE / SPEEDI-SLEEVE
53,98/61,5/19,8/23,8 WELLENSCHUTZHÜLLE / SPEEDI-SLEEVE
55/62/20/23 WELLENSCHUTZHÜLLE / SPEEDI-SLEEVE
56/64,3/12,7/15,9 WELLENSCHUTZHÜLLE / SPEEDI-SLEEVE
57,15/64,3/8/11,1 WELLENSCHUTZHÜLLE / SPEEDI-SLEEVE
57,15/64,3/19,8/23,8 WELLENSCHUTZHÜLLE / SPEEDI-SLEEVE
59,13/69,8/19,1/22,2 WELLENSCHUTZHÜLLE / SPEEDI-SLEEVE
60/70,7/9,4/11,4 WELLENSCHUTZHÜLLE / SPEEDI-SLEEVE
60/70,7/20/23 WELLENSCHUTZHÜLLE / SPEEDI-SLEEVE
60,33/69,8/13,4/17,4 WELLENSCHUTZHÜLLE / SPEEDI-SLEEVE
61,93/71,8/12,7/15,9 WELLENSCHUTZHÜLLE / SPEEDI-SLEEVE
62/71,8/12,7/15,9 WELLENSCHUTZHÜLLE / SPEEDI-SLEEVE
65/72,4/20/23 WELLENSCHUTZHÜLLE / SPEEDI-SLEEVE
65,1/73,4/19,8/23,8 WELLENSCHUTZHÜLLE / SPEEDI-SLEEVE
68/79,4/19,1/22,2 WELLENSCHUTZHÜLLE / SPEEDI-SLEEVE
69,85/79,4/10,3/14,3 WELLENSCHUTZHÜLLE / SPEEDI-SLEEVE
69,85/79,4/19,8/23,79 WELLENSCHUTZHÜLLE / SPEEDI-SLEEVE
69,85/79,4/19,8/23,8 WELLENSCHUTZHÜLLE / SPEEDI-SLEEVE
69,85/79,4/28,6/31,8 WELLENSCHUTZHÜLLE / SPEEDI-SLEEVE
70/79,4/20/24 WELLENSCHUTZHÜLLE / SPEEDI-SLEEVE
71,45/81/15,1/17,5 WELLENSCHUTZHÜLLE / SPEEDI-SLEEVE
72/81,9/19,1/22,2 WELLENSCHUTZHÜLLE / SPEEDI-SLEEVE
75/83,1/15,1/17,5 WELLENSCHUTZHÜLLE / SPEEDI-SLEEVE
75/84/22/26 WELLENSCHUTZHÜLLE / SPEEDI-SLEEVE
76,02/85,3/14,3/17,5 WELLENSCHUTZHÜLLE / SPEEDI-SLEEVE
79,38/89,7/17,5/20,6 WELLENSCHUTZHÜLLE / SPEEDI-SLEEVE
79,91/89,9/19,1/22,5 WELLENSCHUTZHÜLLE / SPEEDI-SLEEVE
80/90/11/15 WELLENSCHUTZHÜLLE / SPEEDI-SLEEVE
80/90/21/24 WELLENSCHUTZHÜLLE / SPEEDI-SLEEVE
84,07/93,7/20,6/25,4 WELLENSCHUTZHÜLLE / SPEEDI-SLEEVE
84,89/94/17/21 WELLENSCHUTZHÜLLE / SPEEDI-SLEEVE
84,89/94/21/25 WELLENSCHUTZHÜLLE / SPEEDI-SLEEVE
85/90,9/10,1/12,7 WELLENSCHUTZHÜLLE / SPEEDI-SLEEVE
88,9/97,6/20,6/25,4 WELLENSCHUTZHÜLLE / SPEEDI-SLEEVE
90/101,6/11,1/13,7 WELLENSCHUTZHÜLLE / SPEEDI-SLEEVE
90/101,6/13,4/16,9 WELLENSCHUTZHÜLLE / SPEEDI-SLEEVE
90/101,6/18/23 WELLENSCHUTZHÜLLE / SPEEDI-SLEEVE
90/101,6/23/28 WELLENSCHUTZHÜLLE / SPEEDI-SLEEVE
94,74/102,2/19,8/23 WELLENSCHUTZHÜLLE / SPEEDI-SLEEVE
95/102,2/21/24 WELLENSCHUTZHÜLLE / SPEEDI-SLEEVE
95/102,4/8,7/12,7 WELLENSCHUTZHÜLLE / SPEEDI-SLEEVE
95/102,5/11,9/15,1 WELLENSCHUTZHÜLLE / SPEEDI-SLEEVE
95,25/102,1/17,5/22,2 WELLENSCHUTZHÜLLE / SPEEDI-SLEEVE
95,25/102,2/14,3/17,5 WELLENSCHUTZHÜLLE / SPEEDI-SLEEVE
100/109,5/20,6/25,4 WELLENSCHUTZHÜLLE / SPEEDI-SLEEVE
101,6/111,1/20,6/25,4 WELLENSCHUTZHÜLLE / SPEEDI-SLEEVE
105/113,5/20/23,2 WELLENSCHUTZHÜLLE / SPEEDI-SLEEVE

109,93/125/12,9/16,5 WELLENSCHUTZHÜLLE / SPEEDI-SLEEVE
115/127/20,6/23,8 WELLENSCHUTZHÜLLE / SPEEDI-SLEEVE
117,5/128,6/25,4/31,8 WELLENSCHUTZHÜLLE / SPEEDI-SLEEVE
120/129,8/20/25 WELLENSCHUTZHÜLLE / SPEEDI-SLEEVE
120,65/127/12,7/19,1 WELLENSCHUTZHÜLLE / SPEEDI-SLEEVE
125/137,2/10/14 WELLENSCHUTZHÜLLE / SPEEDI-SLEEVE
125/137,2/26/32 WELLENSCHUTZHÜLLE / SPEEDI-SLEEVE
127/137,2/17,5/22,2 WELLENSCHUTZHÜLLE / SPEEDI-SLEEVE
129,9/139,5/19,1/23,8 WELLENSCHUTZHÜLLE / SPEEDI-SLEEVE
130,18/139,5/22/25,3 WELLENSCHUTZHÜLLE / SPEEDI-SLEEVE
140/151/20,5/25,4 WELLENSCHUTZHÜLLE / SPEEDI-SLEEVE
145/154,9/19,1/22,2 WELLENSCHUTZHÜLLE / SPEEDI-SLEEVE
150/159/26/30 WELLENSCHUTZHÜLLE / SPEEDI-SLEEVE
160/171,4/25,4/31,8 WELLENSCHUTZHÜLLE / SPEEDI-SLEEVE
165,1/177,8/31,8/0 WELLENSCHUTZHÜLLE / SPEEDI-SLEEVE
169,8/182,6/31,8/38 WELLENSCHUTZHÜLLE / SPEEDI-SLEEVE
171,45/181/20,6/27 WELLENSCHUTZHÜLLE / SPEEDI-SLEEVE
177,8/189,9/25,4/31,8 WELLENSCHUTZHÜLLE / SPEEDI-SLEEVE
180,01/190,5/33/38 WELLENSCHUTZHÜLLE / SPEEDI-SLEEVE
184,86/197,1/32/38 WELLENSCHUTZHÜLLE / SPEEDI-SLEEVE
189,31/199,6/20,6/25,4 WELLENSCHUTZHÜLLE / SPEEDI-SLEEVE
190,5/200/20,6/25,4 WELLENSCHUTZHÜLLE / SPEEDI-SLEEVE
200,03/212,7/34,5/38,1 WELLENSCHUTZHÜLLE / SPEEDI-SLEEVE